

AKtive®

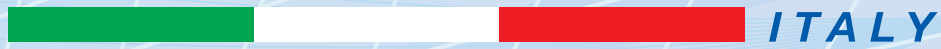

Ophthalmic Instruments



catalogue 2022/23

Rev. 1

Focused on Future



AKTive[®]
Ophthalmic Instruments

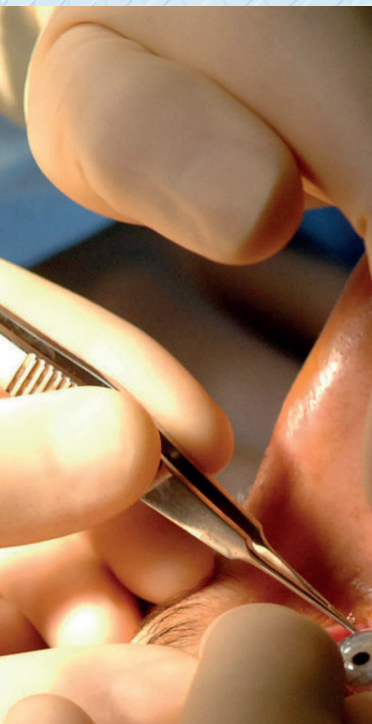

AKTive[®] is a medical device manufacturing company located in Rome, Italy. **AKTive**[®] has been in the distribution business since 2007; by incorporating the company Meditekno in 2011, **AKTive**[®] achieved over 30 years of experience in manufacturing microsurgical instruments for posterior and anterior procedures. Starting from 2012, all the interests have been focused on developing a new line of disposable and semi-disposable instruments.

AKTive[®] produces the finest instruments using modern machining methods with hand finishing by highly skilled instrument makers. Our rigorous quality assurance system meets the requirements for many international controls including ISO 13485:2016 and CE marking, ensuring a consistent production line.

Without losing its artisan origins, **AKTive**[®] leaves open the possibility of manufacturing prototypes from ideas which are geared towards specific surgical requirements.

Our Mission



we would like to provide the highest quality products at a very competitive cost through the use of innovative solutions.

Index Disposable

<i>Retinal Tips, disposable</i>	<i>Tip Retiniche, disposable</i>	p. 4
<i>TWEEZER, disposable retinal forceps and scissors</i>	<i>TWEEZER, pinze e forbici retiniche disposable</i>	p. 5
<i>Vitrectomy Cutters</i>	<i>Manipoli per vitrectomia</i>	p. 6
<i>Trocars & accessories</i>	<i>Trocars & accessori</i>	p. 7
<i>Fiber Optics, Light & Laser</i>	<i>Fibre ottiche, Illuminazione & Laser</i>	p. 8-9
<i>Chandeliers</i>	<i>Candeliere per illuminazione</i>	p. 10
<i>PiC</i>	<i>PiC</i>	p. 10
<i>Infusion Cannulae</i>	<i>Cannule per infusione</i>	p. 12
<i>Backflush & accessories</i>	<i>Backflush & accessori</i>	p. 12-13
<i>Dual bore cannula</i>	<i>Cannula dual bore</i>	p. 13
<i>Visco Fluid Injection Cannula</i>	<i>Cannula per iniezione fluidi viscosi</i>	p. 13
<i>Silicone Oil Injection/Aspiration System</i>	<i>Sistema di infusione/aspirazione Olio di Silicone</i>	p. 14
<i>Eye Shields</i>	<i>Coppette protettive</i>	p. 15
<i>Iris Retractors</i>	<i>Retrattori Iridei</i>	p. 15
<i>Air Injection Tube</i>	<i>Tubo Infusione Aria</i>	p. 15
<i>Scraper</i>	<i>Scraper</i>	p. 15
<i>Phaco Tips</i>	<i>Punte Facò</i>	p. 16
<i>Sleeves</i>	<i>Sleeves</i>	p. 17
<i>Spears</i>	<i>Asciughini</i>	p. 17
<i>Bimanual I/A disposable</i>	<i>I/A Bimanuali monouso</i>	p. 17
<i>By-pass Connectors</i>	<i>Connettori by-pass</i>	p. 18
<i>Tubing Sets</i>	<i>Set di tubi</i>	p. 18
<i>Cannulae</i>	<i>Cannulae</i>	p. 19
<i>Knives and Blades</i>	<i>Bisturi</i>	p. 20-21
<i>Custom Packs</i>	<i>Custom Packs</i>	p. 22
<i>AKti-Flu fluoresceine</i>	<i>AKti-Flu Fluoresceina</i>	p. 29

Index Reusable

CUSTOMIZED SURGICAL INSTRUMENTS

Handles

Capsulorhexis forceps

Choppers

Coaxial irrigation/aspiration

Bi-manual irrigation/aspiration

Surgical trays

Retina tip handpiece

Reusable retinal tips

STRUMENTI CHIRURGICI PERSONALIZZATI

Manici

Pinze per capsuloressi

Choppers

Irrigazione/aspirazione coassiale

Irrigazione/aspirazione bimanuale

Spasette portaferrri

Manipoli per tip retiniche

Tip retiniche pluriuso

p. 24-25

p. 26-27

p. 28

p. 30

p. 31

p. 32

p. 33

p. 34-35

DIAMETER	
GAUGE	MILLIMETERS
15	1,80
16	1,60
17	1,46
18	1,24
19	1,10
20	0,90
21	0,80
22	0,70
23	0,60
24	0,55
25	0,50
26	0,45
27	0,40
28	0,35
30	0,30

Tip retiniche - Retinal Tips

20g - 23g - 25g

PUNTE MONOUSO

DISPOSABLE TIPS

	<p>AK-1666 AK-1670 AK-1671</p>	<p>Micropinza presa in punta per ILM 20g Micropinza presa in punta per ILM 23g Micropinza presa in punta per ILM 25g</p>	<p><i>Microforceps ILM end-gripping 20g</i> <i>Microforceps ILM end-gripping 23g</i> <i>Microforceps ILM end-gripping 25g</i></p>
	<p>AK-1667 AK-1672 AK-1673</p>	<p>Micropinza denti cocodrillo 20 g Micropinza denti cocodrillo 23 g Micropinza denti cocodrillo 25 g</p>	<p><i>Microforceps crocodile teeth 20g</i> <i>Microforceps crocodile teeth 23g</i> <i>Microforceps crocodile teeth 25g</i></p>
	<p>AK-1669 AK-1674 AK-1675</p>	<p>Microforbice retta 20g Microforbice retta 23g Microforbice retta 25g</p>	<p><i>Microscissor straight 20g</i> <i>Microscissor straight 23g</i> <i>Microscissor straight 25g</i></p>
	<p>AK-1668 AK-1676 AK-1683</p>	<p>Microforbice curva 20g Microforbice curva 23g Microforbice curva 25g</p>	<p><i>Microscissor curved 20g</i> <i>Microscissor curved 23g</i> <i>Microscissor curved 25g</i></p>

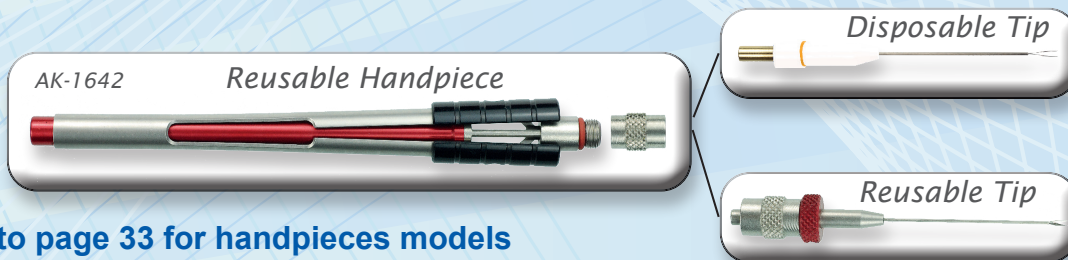

Refer to page 33 for handpieces models
Refer to page 34/35 for reusable tips

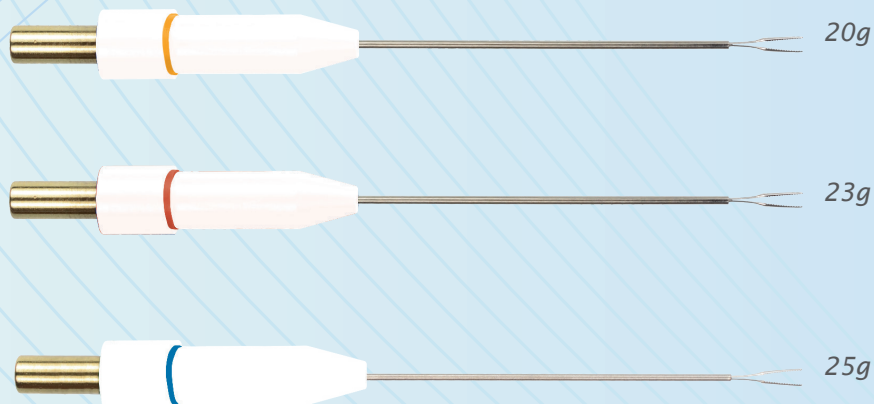

Tweezer

20g - 23g - 25g - 27g

Full disposable retinal forceps & scissors

TWEEZER

PRECISION IN RETINA
ITALY

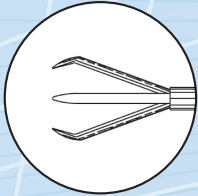

TWEEZER FOREIGN BODY

20g - AK 1666F

spring assisted
no traction

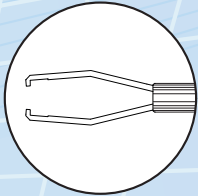

TWEEZER GRIP

20g - AK 1666G
23g - AK 1670G
25g - AK 1671G
27g - AK 1684G

360°
rotatable
handle

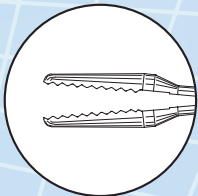

TWEEZER JAWS

20g - AK 1667J
23g - AK 1672J
25g - AK 1673J
27g - AK 1685J

standard length 32 mm
extra long (XL) 37 mm

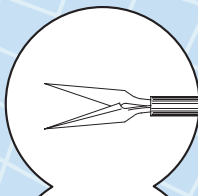

TWEEZER CUT

straight

20g - AK 1669C
23g - AK 1674C
25g - AK 1675C
27g - AK 1687C

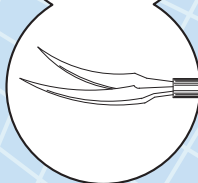

curved

20g - AK 1668V
23g - AK 1676V
25g - AK 1683V
27g - AK 1688V

Color codes:

Yellow 20G

Orange 23G

Blue 25G

Violet 27G

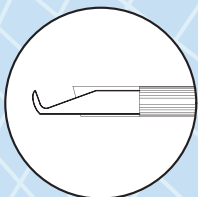

vertical

20g - AK 1691T
23g - AK 1692T
25g - AK 1693T
27g - AK 1694T

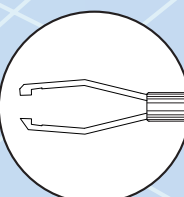

TWEEZER ASYMMETRICAL

20g - AK 1666A
23g - AK 1670A
25g - AK 1671A
27g - AK 1684A

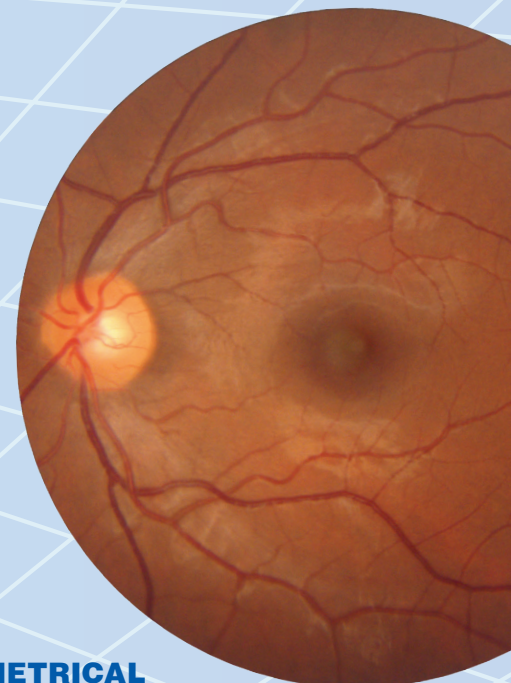
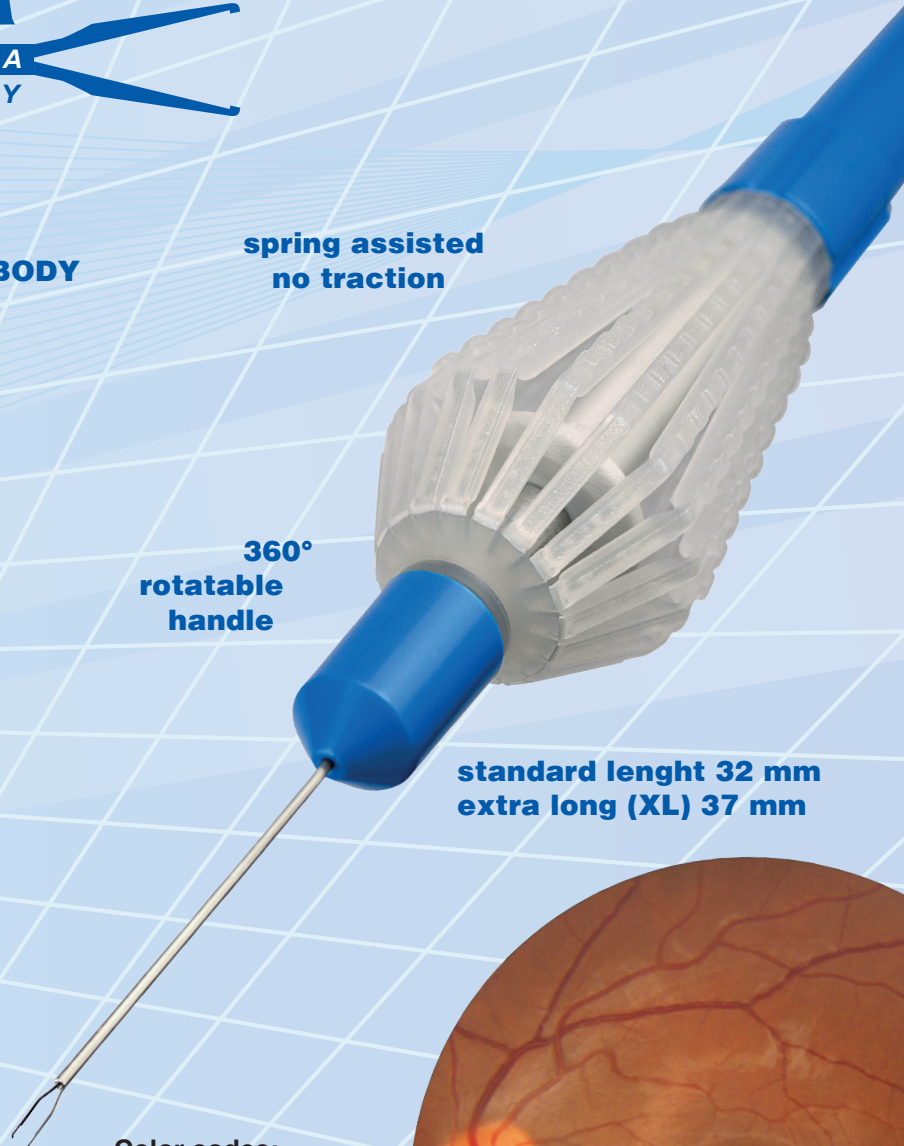

Anterior/Posterior Disposable Vitrectomy Cutters

20g - 23g - 25g - 27g

Vitrectomy Cutters

Color codes:

Yellow 20G

Blue 25G

Orange 23G

Violet 27G

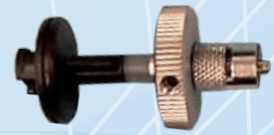
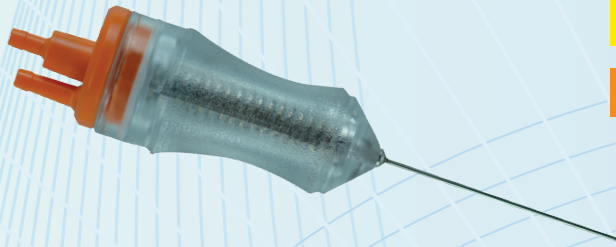

AK-0341



AK-0340/7

Most popular Instruments and their working pressure

INSTRUMENT	PSI	PSI Aktive cutters	Max CPM	20G	23G	25g	27g
ALCON Legacy	20	20	800 single cut 1600 dual cut	AK-0201/AA single cut AK-0201/AA2 dual cut	AK-0231/AA single cut AK-0231/AA2 dual cut		
BAUSCH LOMB Millennium	20	20	800 single cut 1600 dual cut	AK-0215/AB single cut AK-0215/AB2 dual cut	AK-0245/AB single cut AK-0245/AB2 dual cut	AK-0275/AB single cut AK-0275/AB2 dual cut	AK-0294/AB single cut AK-0294/AB2 dual cut
GEUDER Megatron S3	20	20	2000 single cut 4000 dual cut	AK-0200/BA single cut AK-0200/BA2 dual cut	AK-0230/BA single cut AK-0230/BA2 dual cut	AK-0260/BA single cut AK-0260/BA2 dual cut	AK-0286/BA single cut AK-0286/BA2 dual cut
RUCK Pentasys/2	25	25	3000 single cut 6000 dual cut	AK-0206/AA single cut AK-0206/AA2 dual cut	AK-0236/AA single cut AK-0236/AA2 dual cut	AK-0266/AA single cut AK-0266/AA2 dual cut	AK-0288/AA single cut AK-0288/AA2 dual cut
RUCK Qube	25	25	5500 single cut 11000 dual cut	AK-0208/AB single cut AK-0208/AB2 dual cut	AK-0238/AB single cut AK-0238/AB2 dual cut	AK-0268/AB single cut AK-0268/AB2 dual cut	AK-290/AB single cut AK-290/AB2 dual cut
GEUDER Megatron S4(single chamber)	26-27	26-27	6000 single cut 12000 dual cut	AK-0207/BA single cut AK-0207/BA2 dual cut	AK-0237/BA single cut AK-0237/BA2 dual cut	AK-0267/BA single cut AK-0267/BA2 dual cut	AK-0289/BA single cut AK-0289/BA2 dual cut
AMO Signature	29	29	2500 single cut 5000 dual cut	AK-0203/AB single cut AK-0203/AB2 dual cut	AK-0233/AB single cut AK-0233/AB2 dual cut		
OPTIKON Assistant – Pulsar –Antares– AMO Gemini	30	30	2000 single cut 4000 dual cut	AK-0210/AB single cut AK-0210/AB2 dual cut	AK-0240/AB single cut AK-0240/AB2 dual cut	AK-0270/AB single cut AK-0270/AB2 dual cut	AK-0292/AB single cut AK-0292/AB2 dual cut
OPTIKON Rev0 Smart	30	30	5000 single cut 10000 dual cut	AK-0204/AC single cut AK-0204/AB2 dual cut	AK-0234/AB single cut AK-0234/AB2 dual cut	AK-0264/AB single cut AK-0264/AB2 dual cut	AK-0284/AB single cut AK-0284/AB2 dual cut
AMO Sovereign	33	33	800 single cut 1600 dual cut	AK-0202/AA single cut AK-0202/AA2 dual cut	AK-0232/AA single cut AK-0232/AA2 dual cut		
OERTLI OS4	35-37	35-37	5000 single cut 10000 dual cut	AK-0209/EAA single cut AK-0209/EAA2 dual cut	AK-0239/EAA single cut AK-0239/EAA2 dual cut	AK-0269/EAA single cut AK-0269/EAA2 dual cut	AK-0291/EAA single cut AK-0291/EAA2 dual cut
ALCON Accurus	42	42	2000 single cut 4000 dual cut	AK-0220/AC single cut AK-0220/AC2 dual cut	AK-0250/AC single cut AK-0250/AC2 dual cut	AK-0280/AC single cut AK-0280/AC2 dual cut	AK-0295/AC single cut AK-0295/AC2 dual cut
B&L Stellaris	42	42	5000 single cut 10000 dual cut	AK-0205/BF single cut AK-0205/BF2 dual cut	AK-0235/BF single cut AK-0235/BF2 dual cut	AK-0265/BF single cut AK-0265/BF2 dual cut	AK-0287/BF single cut AK-0287/BF2 dual cut
DORC Associate HIGH SPEED/ULTRAVIT	42	42	6000 single cut 12000 dual cut	AK-0219/AC single cut AK-0219/AC2 dual cut	AK-0249/AC single cut AK-0249/AC2 dual cut	AK-0279/AC single cut AK-0279/AC2 dual cut	AK-0297/AC single cut AK-0297/AC2 dual cut
DORC EVA	42	42*	8000 single cut 16000 dual cut	AK-0221/GC single cut AK-0221/GC2 dual cut	AK-0251/GC single cut AK-0251/GC2 dual cut	AK-0281/GC single cut AK-0281/GC2 dual cut	AK-0298/GC single cut AK-0298/GC2 dual cut
OPTIKON Revolution	43	43	6000 single cut 12000 dual cut	AK-0211/AB single cut AK-0211/AB2 dual cut	AK-0241/AB single cut AK-0241/AB2 dual cut	AK-0271/AB single cut AK-0271/AB2 dual cut	AK-0293/AB single cut AK-0293/AB2 dual cut
ZEISS Visalis	43	43	6000 single cut 12000 dual cut	AK-0211/AB single cut AK-0211/AB2 dual cut	AK-0241/AB single cut AK-0241/AB2 dual cut	AK-0271/AB single cut AK-0271/AB2 dual cut	AK-0293/AB single cut AK-0293/AB2 dual cut
ALCON Infiniti	52	52	800 single cut 1600 dual cut	AK-0226/AD single cut AK-0226/AD2 dual cut	AK-0256/AD single cut AK-0256/AD2 dual cut		
ALCON Constellation	52	52*	7500 single cut 15000 dual cut	AK-0225/ABB single cut AK-0225/ABB2 dual cut	AK-0255/ABB single cut AK-0255/ABB2 dual cut	AK-0285/ABB single cut AK-0285/ABB2 dual cut	AK-0299/ABB single cut AK-0299/ABB2 dual cut

*needs adapter

First letter of the code represents the type of connector for the aspiration. Following letters (1 or 2) represent the pressure line connectors. If there is the number 2 it means it is a dual cut

To choose the most suitable Vit cutter for your equipment you need to know:

- PSI of the instrument.
- The maximum cutting speed (CPM)**.
- The gauge (20-23-25-27g).
- Single cut or dual cut blade.

If you do not know the operating pressure of your equipment (expressed in psi) refer to the table you see above, which shows the values of the most popular equipments. Once you know your reference PSI, go to the table of AKTIVE vit cutters and position yourself on the PSI corresponding to your value. You may find for the same PSI value different suggestions. Choose in the row that is closest in CPM value. Now that you have located the model that comes closer for PSI and CPM you can decide on the gauge and whether the blade should be single cut or dual cut. The code will show 2 or 3 letters. The first indicates the type of connector for the aspiration, while the second or third letter represents the type of connector for the pneumatic drive operated by the instrument. Check for correspondence with the list of connectors below. It is important for the user to be aware that AKTive is a vit cutter manufacturer. Many users use AKTive vit cutters with connections to their own equipment. Connection to any of these instruments is the responsibility of the user and in no way constitutes a statement of compatibility

Contact us to help your choice.

** The CPM is given by the manufacturer of the instrument. It represents the maximum impulses the instrument can give to the cutter. Some manufacturers of equipment find easy to say that the machine is 16.000 CPM (in dual cut); the effective impulses are 8.000, applied to a blade that makes the effect double.

EXAMPLE VIT CUTTER: AK-0255/ABB2

AK-0255	A	B	B	2
Cutter 23g 52 psi	Type of pressure connector	Type of pressure connector	Type of pressure connector	Dual cut

Anterior/Posterior Disposable Vitrectomy Cutters

20g - 23g - 25g - 27g

According to the model the body can be transparent or white

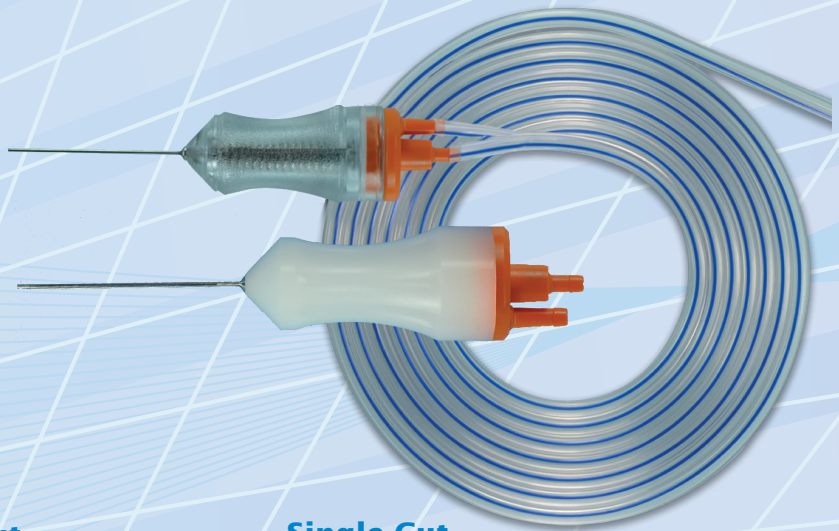

Dual Cut

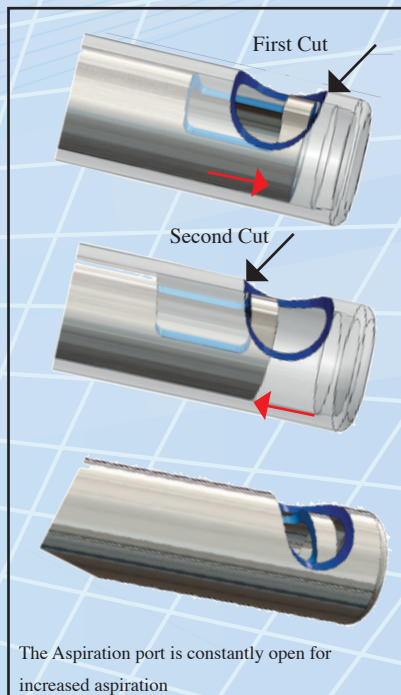

Single Cut

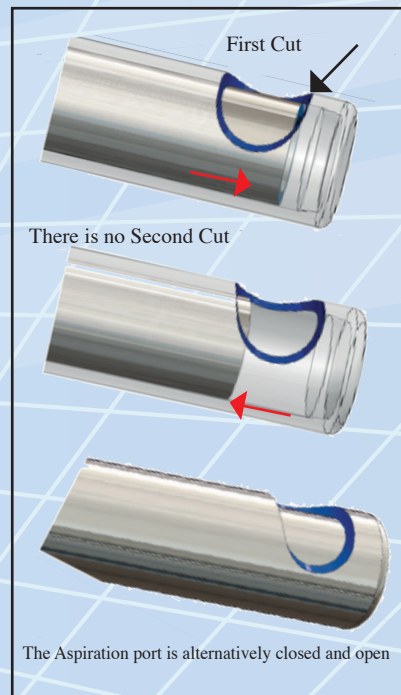

AK-0398

Pressure line adapter, connector A-D
1 per box (non-sterile)
AVAILABLE DIFFERENT COMBINATIONS

Choose your customized connector for your aspiration line and pressure line



A



B



C



D



E



F



G



H

Fiber Optic Probes for illumination

20g - 23g - 25g - 27g

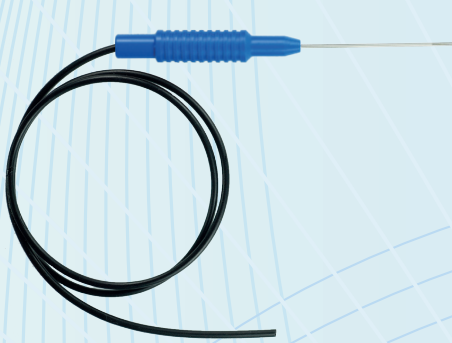

Standard fiber

Color codes:

Yellow 20G

Blue 25G

Orange 23G

Violet 27G

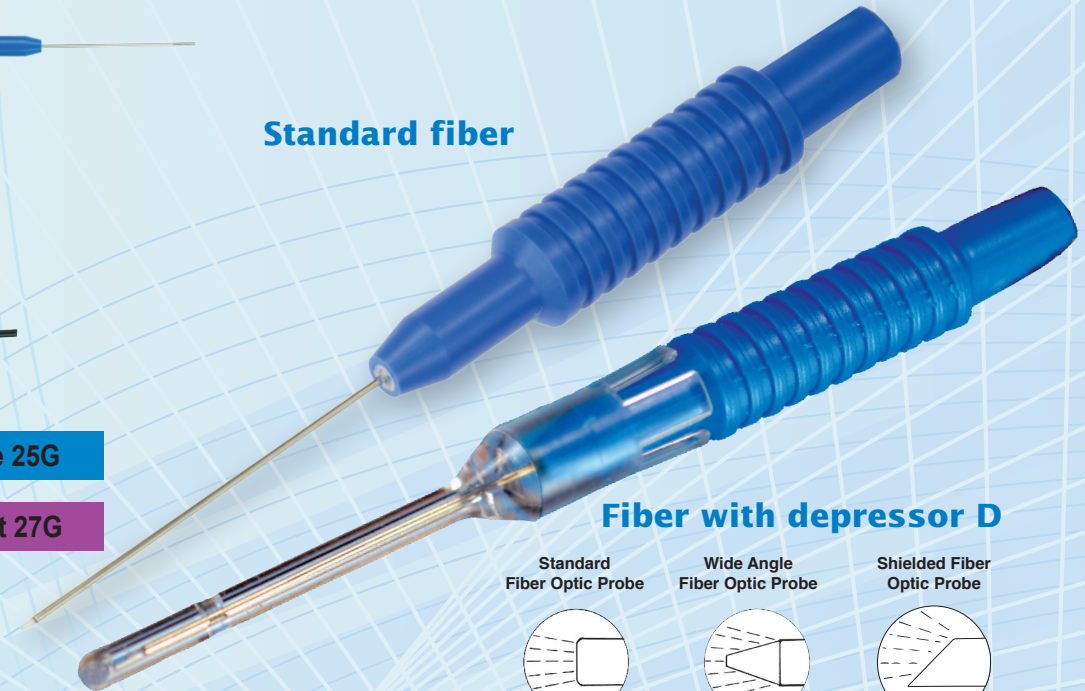

Fiber with depressor D

Standard Fiber Optic Probe

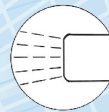

Wide Angle Fiber Optic Probe

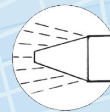

Shielded Fiber Optic Probe



Depressor D



Guide

To choose the best fiber for your instrument, you need to know the type of connector your instrument has. Below is a table representing the most popular equipments on the market. Each has been assigned a letter. Identify which type of attachment best suits your instrument.

It now remains to decide what type of illumination you need: standard, wide angle or shielded. Finally the gauge, choose between 20-23-25-27.

At the end of each code you will find a letter. Choose the one that corresponds to your instrument.

You are now ready to determine exactly your fiber.

It is important for the user to know that AKtive is a fiber optic manufacturer. Many users use fiber optics from AKtive with connections to their own equipment. Connection to any of these instruments is the responsibility of the user and in no way constitutes a statement of compatibility. Please contact us to help you with your choice.

Standard Light Pipe			
20g	23g	25g	27g
AK-0420/A	AK-0422/A	AK-0424/A	AK-0530/A
AK-0420/B	AK-0422/B	AK-0424/B	AK-0530/B
AK-0420/T	AK-0422/T	AK-0424/T	AK-0530/T
AK-0420/K	AK-0422/K	AK-0424/K	AK-0530/K
AK-0420/D	AK-0422/D	AK-0424/D	AK-0530/D
AK-0420/S	AK-0422/S	AK-0424/S	AK-0530/S
AK-0420/R	AK-0422/R	AK-0424/R	AK-0530/R
AK-0420/E	AK-0422/E	AK-0424/E	AK-0530/E
AK-0420/G	AK-0422/G	AK-0424/G	AK-0530/G

Wide Angle		
20g	23g	25g
AK-0421/A	AK-0423/A	AK-0425/A
AK-0421/B	AK-0423/B	AK-0425/B
AK-0421/T	AK-0423/T	AK-0425/T
AK-0421/K	AK-0423/K	AK-0425/K
AK-0421/D	AK-0423/D	AK-0425/D
AK-0421/S	AK-0423/S	AK-0425/S
AK-0421/R	AK-0423/R	AK-0425/R
AK-0421/E	AK-0423/E	AK-0425/E
AK-0421/G	AK-0423/G	AK-0425/G

Shielded		
20g	23g	25g
AK-0426/A	AK-0427/A	AK-0428/A
AK-0426/B	AK-0427/B	AK-0428/B
AK-0426/T	AK-0427/T	AK-0428/T
AK-0426/K	AK-0427/K	AK-0428/K
AK-0426/D	AK-0427/D	AK-0428/D
AK-0426/S	AK-0427/S	AK-0428/S
AK-0426/R	AK-0427/R	AK-0428/R
AK-0426/E	AK-0427/E	AK-0428/E
AK-0426/G	AK-0427/G	AK-0428/G

Upon request the fibers can be supplied with the special "depressor D", used as illuminated depressor.

INSTRUMENT
ALCON=A
B&L=B
OPTIKON 1=T
OPTIKON 2=K
DORC=D
SYNERGETICS=S
RUCK=R
OERTLI=E
GEUDER=G

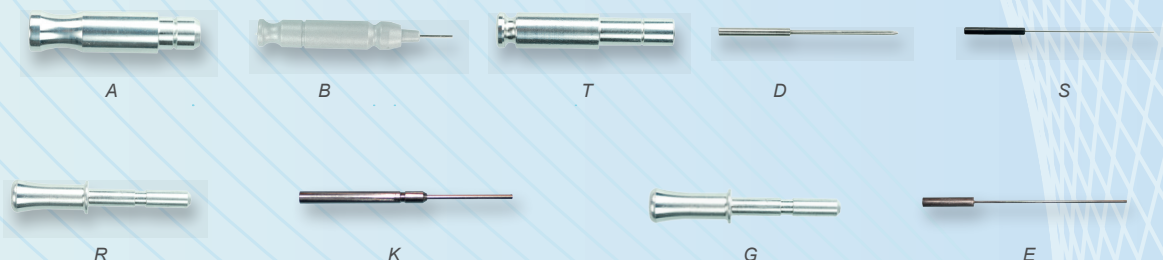

Fiber Optic Probes for Laser

20g - 23g - 25g - 27g

Laser fibers

Standard

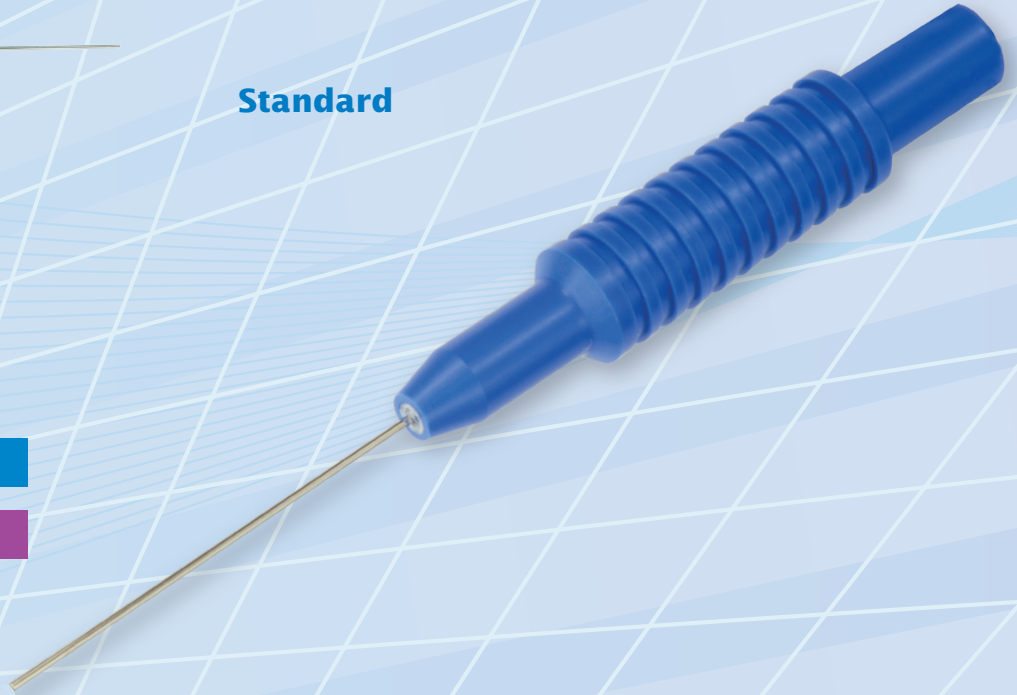
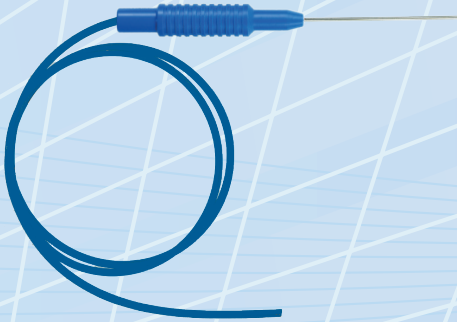

Color codes:

Yellow 20G

Blue 25G

Orange 23G

Violet 27G

Straight			
20g	23g	25g	27g
AK-0430/SMA	AK-0431/SMA	AK-0432/SMA	AK-0433/SMA
AK-0430/QTL	AK-0431/QTL	AK-0432/QTL	AK-0433/QTL
AK-0430/LMN	AK-0431/LMN	AK-0432/LMN	AK-0433/LMN
AK-0430/DRC	AK-0431/DRC	AK-0432/DRC	AK-0433/DRC

Curved			
20g	23g	25g	27g
AK-0434/SMA	AK-0435/SMA	AK-0436/SMA	AK-0437/SMA
AK-0434/QTL	AK-0435/QTL	AK-0436/QTL	AK-0437/QTL
AK-0434/LMN	AK-0435/LMN	AK-0436/LMN	AK-0437/LMN
AK-0434/DRC	AK-0435/DRC	AK-0436/DRC	AK-0437/DRC

Guide

To choose the best fiber for your instrument, you need to know the type of connector your instrument has. Below is a table representing the most popular equipments on the market. Each has been assigned 3 Letter Code. Identify which type of attachment best suits your instrument.

Laser fiber Extensible		
20g	23g	25g
AK-0430/SMA-EX	AK-0431/SMA-EX	AK-0432/SMA-EX
AK-0430/QTL-EX	AK-0431/QTL-EX	AK-0432/QTL-EX
AK-0430/LMN-EX	AK-0431/LMN-EX	AK-0432/LMN-EX
AK-0430/DRC-EX	AK-0431/DRC-EX	AK-0432/DRC-EX

Connector
ALCON-ZEISS-COHERENT-ELLEX- = SMA (905)
QUANTEL=QTL (ST)
LUMENIS=LMN (906)
DORC: DRC

Extensible

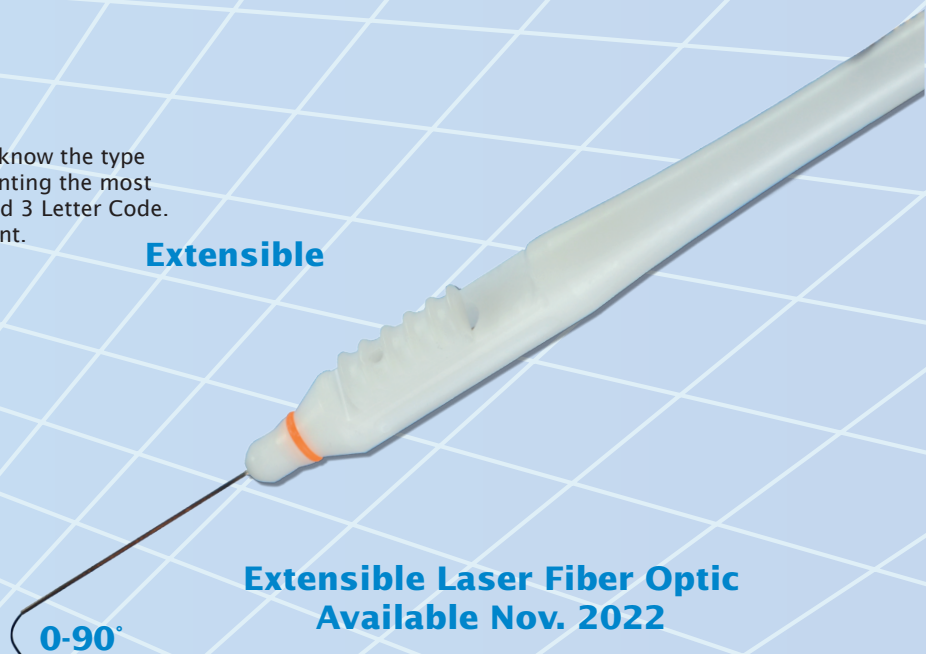

Extensible Laser Fiber Optic Available Nov. 2022

Laser connectors



Thread SMA



QTL



Thread DRC



LMN

Retinal Chandelier

20g - 23g - 25g - 27g



Chandelier 20g

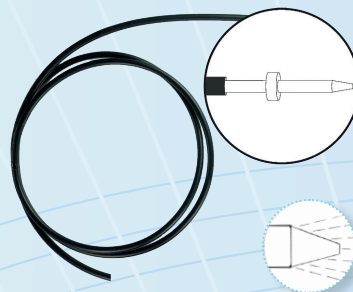

Chandelier 23 - 25 - 27g

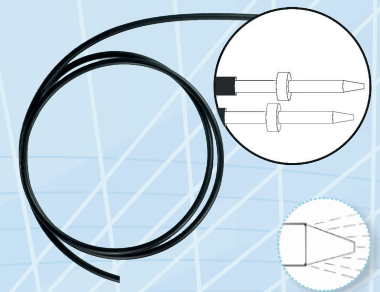

Chandelier 27g dual fiber

CHANDELIERS supplied with no accessories

Connector	Chandelier 20G	Chandelier 23G	Chandelier 25G	Chandelier 25 dual fiber	Chandelier 27G	Chandelier 27G dual fiber
ALCON=A	AK-0415/A	AK-0416/A	AK-0417/A	AK-0472/A	AK-0460/A	AK-0471/A
B&I=B	AK-0415/B	AK-0416/B	AK-0417/B	AK-0472/B	AK-0460/B	AK-0471/B
OPTIKON 1=T	AK-0415/T	AK-0416/T	AK-0417/T	AK-0472/T	AK-0460/T	AK-0471/T
OPTIKON 2=K	AK-0415/K	AK-0416/K	AK-0417/K	AK-0472/K	AK-0460/K	AK-0471/K
DORC=D	AK-0415/D	AK-0416/D	AK-0417/D	AK-0472/D	AK-0460/D	AK-0471/D
SYNERGETICS=S	AK-0415/S	AK-0416/S	AK-0417/S	AK-0472/S	AK-0460/S	AK-0471/S
RUCK=R	AK-0415/R	AK-0416/R	AK-0417/R	AK-0472/R	AK-0460/R	AK-0471/R
OERTLI=E	AK-0415/E	AK-0416/E	AK-0417/E	AK-0472/E	AK-0460/E	AK-0471/E
GEUDER=G	AK-0415/G	AK-0416/G	AK-0417/G	AK-0472/G	AK-0460/G	AK-0471/G

CHANDELIERS supplied with pre-loaded TROCAR+ INSERTER

Connector	Chandelier 20G	Chandelier 23G	Chandelier 25G
ALCON=A	AK-0414/A	AK-0418/A	AK-0419/A
B&I=B	AK-0414/B	AK-0418/B	AK-0419/B
OPTIKON 1=T	AK-0414/T	AK-0418/T	AK-0419/T
OPTIKON 2=K	AK-0414/K	AK-0418/K	AK-0419/K
DORC=D	AK-0414/D	AK-0418/D	AK-0419/D
SYNERGETICS=S	AK-0414/S	AK-0418/S	AK-0419/S
RUCK=R	AK-0414/R	AK-0418/R	AK-0419/R
OERTLI=E	AK-0414/E	AK-0418/E	AK-0419/E
GEUDER=G	AK-0414/G	AK-0418/G	AK-0419/G

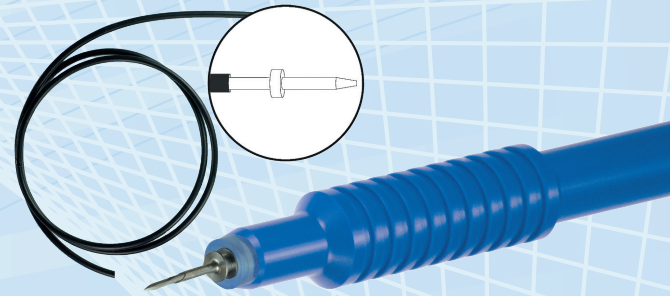

INSTRUMENT
ALCON=A
B&I=B
OPTIKON 1=T
OPTIKON 2=K
DORC=D
SYNERGETICS=S
RUCK=R
OERTLY=E
GEUDER=G

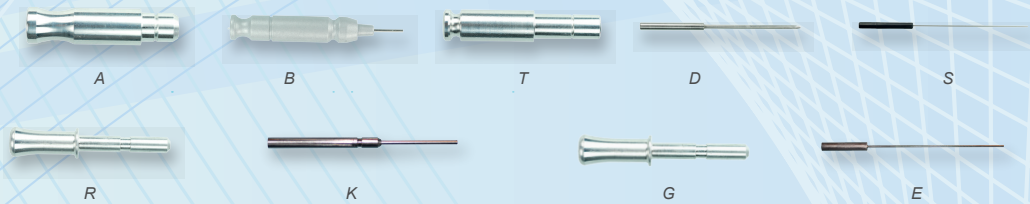

Illuminated Retinal Pic - Retinal Pic

20 - 23 - 25g

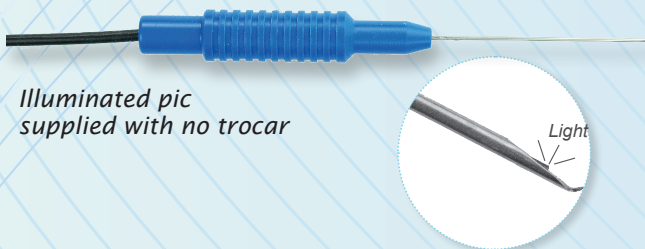

Illuminated pic supplied with no trocar



Standard pic

Connector	Illuminated Pic 20G	Illuminated Pic 23G	Illuminated Pic 25G
ALCON=A	AK-0407/A	AK-0408/A	AK-0409/A
B&I=B	AK-0407/B	AK-0408/B	AK-0409/B
OPTIKON 1=T	AK-0407/T	AK-0408/T	AK-0409/T
OPTIKON 2=K	AK-0407/K	AK-0408/K	AK-0409/K
DORC=D	AK-0407/D	AK-0408/D	AK-0409/D
SYNERGETICS=S	AK-0407/S	AK-0408/S	AK-0409/S
RUCK=R	AK-0407/R	AK-0408/R	AK-0409/R
OERTLI=E	AK-0407/E	AK-0408/E	AK-0409/E
GEUDER=G	AK-0407/G	AK-0408/G	AK-0409/G

Standard PIC 20G	Standard PIC 23G	Standard PIC 25G	Standard PIC 27G
AK-0410	AK-0411	AK-0412	AK-0413

Disposable Trocar sets

20g - 23g - 25g - 27g

Color codes:

Yellow 20G

Orange 23G

Blue 25G

Violet 27G

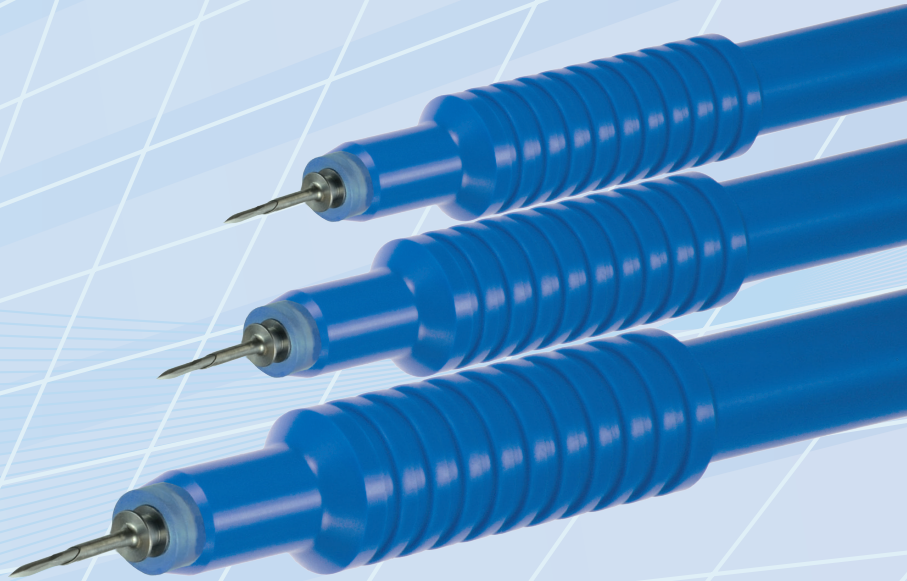

Package includes:

- Disposable preloaded valved trocar - 3 pcs
- Sharp blade cannula inserter - 3 pcs
- Infusion line for bss - 1 pc

TROCAR SET WITH REMOVABLE VALVE

AK-0349/N AK-0350/N	20g Trocar Set 23g Trocar Set
AK-0351/N AK-0344/N	25g Trocar Set 27g Trocar Set

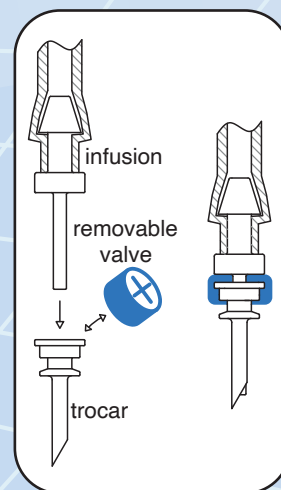
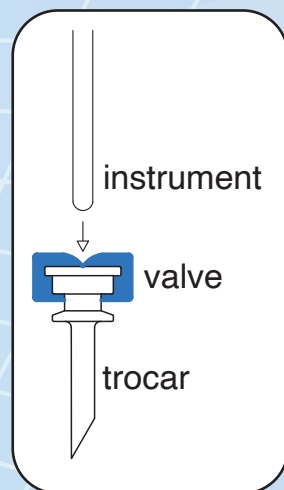

Accessories

Reinforced Silicone Oil infusion line

AK-0359/N	For Trocar 20g
AK-0357/N	For Trocar 23g
AK-0358/N	For Trocar 25g

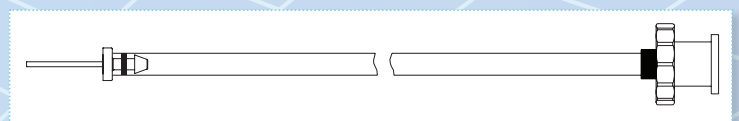

AK-0363	Loading Forceps (reusable)
---------	----------------------------



Retinal Cannulae - Anterior Chamber Maintainers

Infusion Cannulae 20g - with Suturing Wings

BSS/Air infusion

AK-0390	BSS/Air Infusion Cannula 20g, 2.5mm, suturing wings
AK-0391	BSS/Air Infusion Cannula 20g, 4.0mm, suturing wings
AK-0392	BSS/Air Infusion Cannula 20g, 6.0mm, suturing wings

Silicone oil infusion

AK-0393	Silicone Oil Infusion Cannula 20g, 4.0mm silicone use, suturing wings
AK-0394	Silicone Oil Infusion Cannula 20g, 6.0mm silicone use, suturing wings

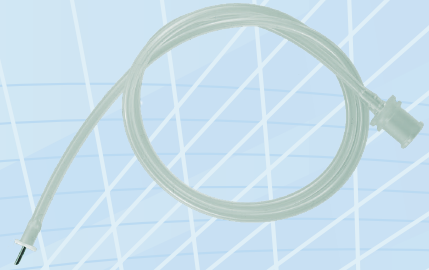
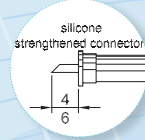
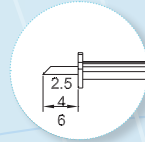

Anterior Chamber Maintainers

AK-0333	18g anterior chamber maintainer
AK-0334	20g anterior chamber maintainer

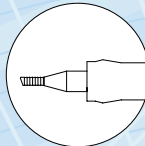

AK-0335	23g anterior chamber maintainer
AK-0332	25g anterior chamber maintainer

Disposable Backflush full handle

Disposable Backflush full handle - Active/Passive

Can be used in both active or passive way

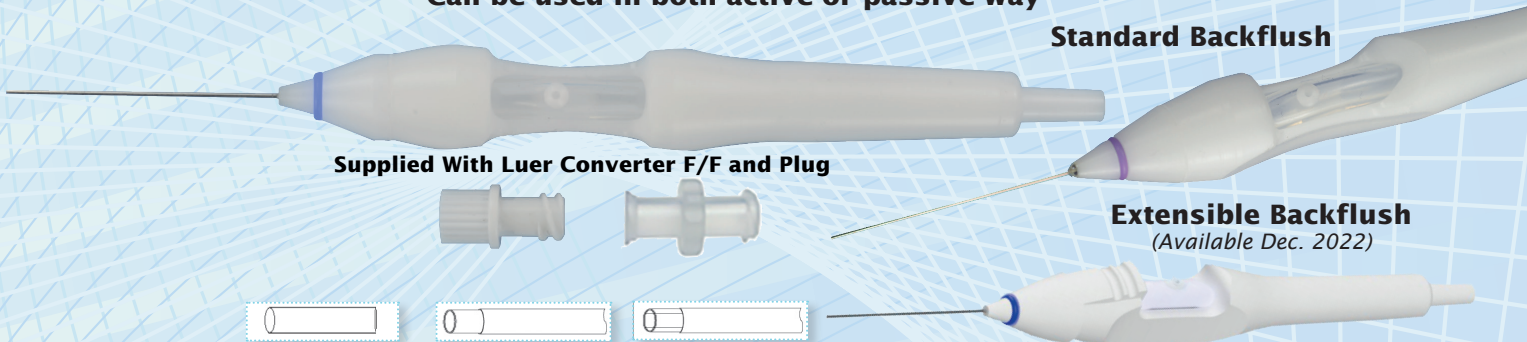

Supplied With Luer Converter F/F and Plug

	Standard, Charles	Soft Tip	Brush Tip
20g	AK-0451/AP	AK-0452/AP	AK-0453/AP
23g	AK-0454/AP	AK-0455/AP	AK-0456/AP
25g	AK-0457/AP	AK-0458/AP	AK-0459/AP
27g	AK-0464/AP	AK-0465/AP	AK-0466/AP

	Extensible Backflush	
	Soft tip	Brush tip
20g	AK-0452/AP-EX	AK-0453/AP-EX
23g	AK-0455/AP- EX	AK-0456/AP- EX
25g	AK-0458/AP-EX	AK-0459/AP-EX

Reusable Backflush Handpiece for Disposable and Reusable Tips

Backflush handpiece – Passive reusable (non-sterile)



AK-0481	Universal Connector
---------	---------------------

Backflush handpiece - Active reusable (non-sterile)



AK-0483	Universal Connector
---------	---------------------

Backflush Disposable Cannulae Tips

Universal L/L connector



	Standard	Soft Tip	Brush Tip
20g	AK-0509	AK-0510	AK-0511
23g	AK-0512	AK-0513	AK-0514
25g	AK-0515	AK-0516	AK-0517
27g	AK-0523	AK-0524	AK-0525

Dual bore cannula

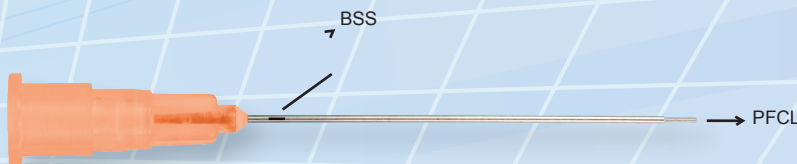

20g	AK-0518	Dual Bore Cannula, 20g mm 32
23g	AK-0519	Dual Bore Cannula, 23g mm 32
25g	AK-0520	Dual Bore Cannula, 25g mm 32
27g	AK-0527	Dual Bore Cannula, 27g mm 32
23g	AK-0519/XL	Dual Bore Cannula, 23g mm 36
25g	AK-0520/XL	Dual Bore Cannula, 25g mm 36

Visco-Fluid injection cannula



23g	AK-0521	Visco Fluid Injection Cannula Disposable, 23g
25g	AK-0522	Visco Fluid Injection Cannula Disposable, 25g

Reservoirs for Backflush Instruments

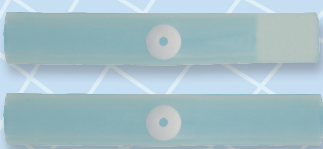

AK-0440	Passive Replacement Reservoir, (sterile)
AK-0441	Active Replacement Reservoir, (sterile)

Oil Injection/Aspiration System

For syringe Ø 14,5mm

Description	Kit	Code
High pressure injection/aspiration system fits Ø 14,5 syringe - Connector A	Without syringe	AK-0383/A
	With syringe	AK-0383/AS
High pressure injection/aspiration system fits Ø 14,5 syringe - Connector B	Without syringe	AK-0383/B
	With syringe	AK-0383/BS
High pressure injection/aspiration system fits Ø 14,5 syringe - Connector C	Without syringe	AK-0383/C
	With syringe	AK-0383/CS
High pressure injection/aspiration system fits Ø 14,5 syringe - Connector D	Without syringe	AK-0383/D
	With syringe	AK-0383/DS
High pressure injection/aspiration system fits Ø 14,5 syringe - Connector E	Without syringe	AK-0383/E
	With syringe	AK-0383/ES
High pressure injection/aspiration system fits Ø 14,5 syringe - Connector F	Without syringe	AK-0383/F
	With syringe	AK-0383/FS
High pressure injection/aspiration system fits Ø 14,5 syringe - Connector G	Without syringe	AK-0383/G
	With syringe	AK-0383/GS
High pressure injection/aspiration system fits Ø 14,5 syringe - Connector H	Without syringe	AK-0383/H
	With syringe	AK-0383/HS

For aspiration or infusion of visco fluids

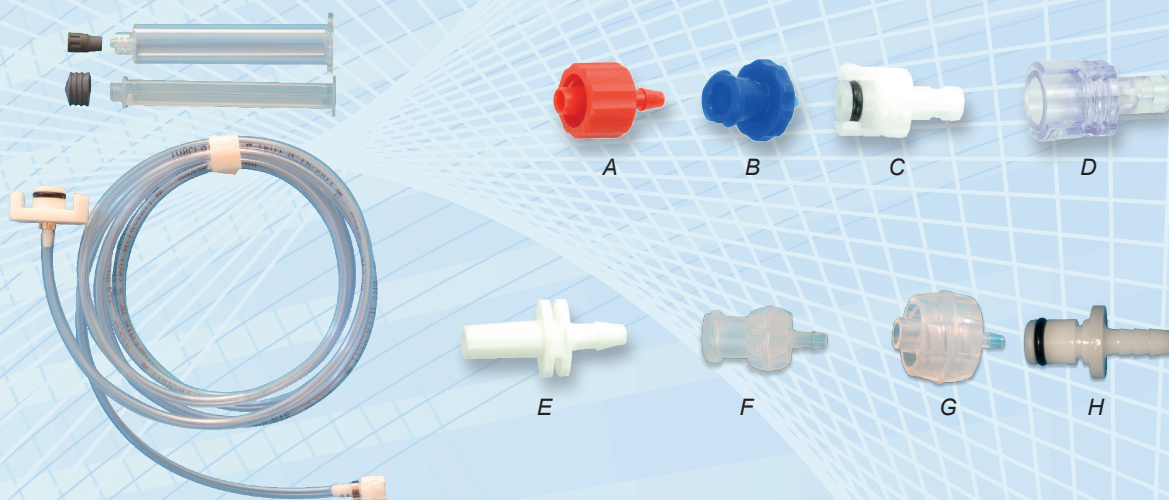

Supplied without syringe

For syringe Ø 14,0mm (not supplied)

Description	Kit	Code
High pressure injection/aspiration system fits Ø 14 syringe - Connector A	Without syringe	AK-0383/A2
High pressure injection/aspiration system fits Ø 14 syringe - Connector B	Without syringe	AK-0383/B2
High pressure injection/aspiration system fits Ø 14 syringe - Connector C	Without syringe	AK-0383/C2
High pressure injection/aspiration system fits Ø 14 syringe - Connector D	Without syringe	AK-0383/D2
High pressure injection/aspiration system fits Ø 14 syringe - Connector E	Without syringe	AK-0383/E2
High pressure injection/aspiration system fits Ø 14 syringe - Connector F	Without syringe	AK-0383/F2
High pressure injection/aspiration system fits Ø 14,5 syringe - Connector G	Without syringe	AK-0383/G2
High pressure injection/aspiration system fits Ø 14,5 syringe - Connector H	Without syringe	AK-0383/H2

Eye Protection

Eye shields

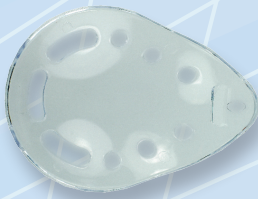

AK-2001	eye shield, transparent, (non-sterile), left or right eye
AK-2000	eye shield, transparent, (sterile), left or right eye

Iris Retractors



AK-0490	1 set of 4 retractors - disposable
AK-0492	1 set of 5 retractors - disposable
AK-0491	1 set of 6 retractors - reusable

Scraper

AK-0512/S	Scraper 23g
AK-0515/S	Scraper 25g
AK-0523/S	Scraper 27g



Available Nov. 2022

Air Injection Tube

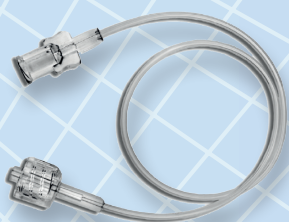

AK-0380	Air Injection Tube 70cm
AK-0381	Air Injection Tube 140cm
AK-0382	Air Injection Tube 200cm

Choose your customized connector for your aspiration line and pressure line
For connectors refer to page 6

Reusable & Disposable Phaco Needles

(All tips are available in disposable packages too.)



Phaco Needle, 19g American Thread

AK-1701A/B/C/T/K	Phaco Needle, 19g, 0° -1 per box
AK-1702A/B/C/T/K	Phaco Needle, 19g, 15° - 1 per box
AK-1703A/B/C/T/K	Phaco Needle, 19g, 30° - 1 per box
AK-1704A/B/C/T/K	Phaco Needle, 19g, 45° - 1 per box
Use Recommended for A = Alcon, B = AMO, C = B&L	

Phaco Needle, 21g American Thread

AK-1725A/B/C/T/K	Phaco Needle, 21g, 0°, straight
AK-1726A/B/C/T/K	Phaco Needle, 21g, 15°, straight
AK-1727A/B/C/T/K	Phaco Needle, 21g, 30°, straight
AK-1728 G	Phaco Needle, 21g, 15°, Curved 22°
AK-1729 G	Phaco Needle, 21g, 30°, Curved 22°
AK-1720D/E	Phaco Needle, 21g, 30°, Curved 10° or 22°
AK-1730/G	Phaco Needle, 21g, 30°, Curved 10° reverse
AK-1721D/E	Phaco Needle, 21g, 45°, Curved 10° or 22°

Use Recommended for: A = ALCON, B and G = AMO, C = B&L, D and E = Alcon Torsional

Phaco Needle, 22g American Thread

AK-1722 A/B/C/T/K	Phaco Needle, 22g, 0°, straight
AK-1723 A/B/C/T/K	Phaco Needle, 22g, 15°, straight
AK-1724 A/B/C/T/K	Phaco Needle, 22g, 30°, straight
AK-1712/G	Phaco Needle, 22g, 15°, Curved 22°
AK-1713/G	Phaco Needle, 22g, 30°, Curved 22°
AK-1739/D	Phaco Needle, 22g, 30°, Curved 10°
AK-1714/G	Phaco Needle, 22g, 30°, Curved 10° reverse
AK-1739/E	Phaco Needle, 22g, 45°, Curved 22°

Phaco Needle, 20g American Thread

AK-1715A/B/C/T/K	Phaco Needle, 20g, 0°, straight
AK-1716 A/B/C/T/K	Phaco Needle, 20g, 15°, straight
AK-1717 A/B/C/T/K	Phaco Needle, 20g, 30°, straight
AK-1718 G	Phaco Needle, 20g, 15°, Curved 22°
AK-1719 G	Phaco Needle, 20g, 30°, Curved 22°
AK-1710D/E	Phaco Needle, 20g, 30°, Curved 10° or 22°
AK-1720G	Phaco Needle, 20g, 30°, Curved 10° reverse
AK-1711D/E	Phaco Needle, 20g, 45°, Curved 10° or 22°
Use Recommended for A = ALCON, B and G = AMO, C = B&L, D and E = Alcon Torsional	

Phaco Needle, Metric Thread

	Angle 0°	Angle 15°	Angle 30°
19g	AK-1730F	AK-1733F	AK-1736F
20g	AK-1731F	AK-1734F	AK-1737F
21g	AK-1732F	AK-1735F	AK-1738F
Use Recommended for OPTIKON			

All needles available in disposable & reusable models

disposable blister composition:	reusable blister composition:
- needle - sleeve - test chamber - wrench	- needle
Models A and F have no sleeve	Protection can be used as wrench at first use but can not be sterilized



Phaco Accessories



AK-1746	Irrigation Sleeve, 20g reusable American Thread
AK-1747	Irrigation Sleeve, 21g reusable American Thread
AK-1746.1	Irrigation Sleeve, 22g reusable American Thread

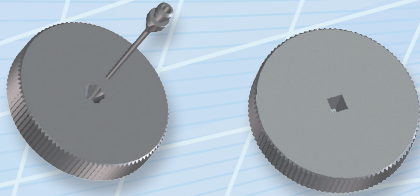

AK-1743	Reusable Wrench Star non-sterile
AK-1744	Reusable Wrench square type non-sterile

Spears

PVA Eye Spears



A-0405	<ul style="list-style-type: none"> • Lint-free PVA material • Compressed spears are ideal for controlling and absorbing fluid in and around the orbital area during cataract or refractive procedure • 180 pcs box (18 blisters of 10 pcs each)
--------	----------------------------------------------------------------------------------------------------------------------------------------------------------------------------------------------------------------------------------------------------------------------------------

Irrigation/Aspiration Disposable Bi-Manual Handpieces



AK-0439	Set bi-manual I/A handpieces 21g -20 per box Irrigation double port 0.40mm - aspiration single port 0.35mm - disposable
---------	-------------------------------------------------------------------------------------------------------------------------

By-pass Connectors

Type A

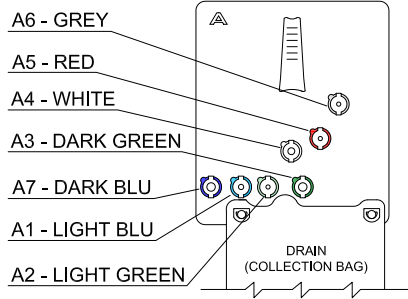

AK-0340/1	Connector A1, reusable (light blue)
AK-0340/2	Connector A2, reusable (light green)
AK-0340/3	Connector A3, reusable (dark green)
AK-0340/4	Connector A4, reusable (white)
AK-0340/5	Connector A5, reusable (red)
AK-0340/6	Connector A6, reusable (grey)
AK-0340/7	Connector A7, reusable (dark blue)
AK-0341	Connector VIT
AK-0340/SET	Connectors set A : AK-0340/1 + AK-0340/2 + AK-0340/3 + AK-0340/4 AK-0340/5 + AK-0340/6 + AK-0340/7 + AK-0341x2 pcs

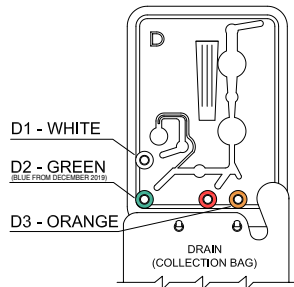

Type D

AK-0342/1	Connector D1, reusable (white)
AK-0342/2	Connector D2, reusable (blue) - Becomes blue 2019
AK-0342/3	Connector D3, reusable (orange)
AK-0342/SET	Connectors set D : AK-0342/1 + AK-0342/2 + AK-0342/3

Tubings/Sets

Type A

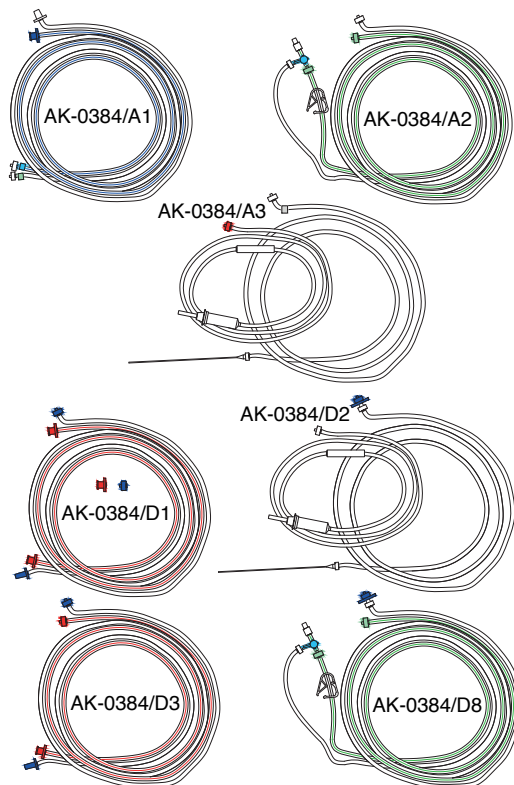

AK-0384/A1	Infusion/aspiration tubing A1
AK-0384/A2	Air/fluid tubing A2
AK-0384/A3	Assisted Infusion set A3
AK-0384/A4	Tubing set A4 - AK-0384/A1 Infusion/aspiration tubing A1 - AK-0384/A2 Air/fluid tubing A2 - AK-0384/A3 Assisted infusion Set A3
AK-0384/A5	Tubing set A5 - AK-0384/A1 Infusion/aspiration tubing A1 - AK-0384/A3 Assisted infusion Set A3

Type D

AK-0384/D1	Infusion/aspiration tubing D1
AK-0384/D2	Assisted Infusion set D2
AK-0384/D3	Infusion/aspiration tubing D3
AK-0384/D4	Tubing set D4 - AK-0384/D1 Infusion/aspiration tubing D1 - AK-5291 Infusion line
AK-0384/D5	Tubing set D5 - AK-0384/D3 Infusion/aspiration tubing D3 - AK-5291 Infusion line
AK-0384/D6	Tubing set D6 - AK-0384/D2 Assisted infusion Set D2 - AK-0384/D3 Infusion/aspiration tubing D3
AK-0384/D7	Tubing set D7 - AK-0384/D2 Assisted infusion Set D2 - AK-0384/D3 Infusion/aspiration tubing D3 - AK-0384/D8 Air/fluid tubing D8
AK-0384/D8	Air/fluid tubing D8

Attention: the tubings/sets are non-specific medical devices for fluid/air connections with a maximum pressure of 20 psi. Connection to any medical devices are the sole responsibility of the user.

Cannulae

Disposable cannulae

Anesthesia Administration

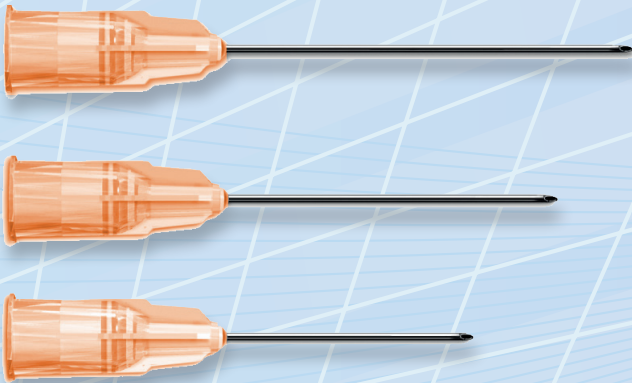

Atkinson Tip Retrobulbars

1638	23g x 1 1/2" (38mm)
1637	25g x 1 1/2" (38mm)

Atkinson Tip Peribulbars

1641	23g x 1 1/4" (32mm)
5144	23g x 7/8" (22mm)
5027	25g x 7/8" (22mm)
5145	27g x 7/8" (22mm)
5200	30g x 1/2" (12,7mm)

Capsulotomy

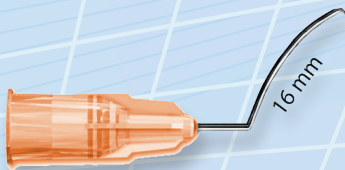

Irrigating Cystotomes

8mm bend to tip (formed)

5049	25g x 5/8" (16mm)
5050	27g x 5/8" (16mm)

Hydrodissection

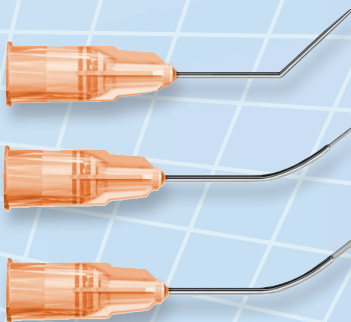

Nucleus Hydrodissection Cannula

7/8" 22mm Long with Flattened tip

5037	25g 8mm bend to tip
5158	27g 11mm bend to tip

Nucleus Hydrodissection Cannula

5099	27g x7/8mm (22mm) Curved (Sauter)
5155	27g x7/8mm (22mm) Curved horizontal

Irrigation, Air Injection & Viscoelastic



Anterior Chamber Irrigator

22mm Long with round tip, angled 45°

5026	Visco Cannula, 27g, 9mm bend to tip
1639	Irrigation, Rycroft, 25g, 4mm bend to tip
1280	Irrigation, Rycroft, 27g, 4mm bend to tip
5124	Irrigation, 25g, 12mm bend to tip
1273	irrigation 30g, 4mm bend to tip

Lacrimal

Lacrimal Cannula

Used to open up drainage or lacrimal system
Open ended



1615	21g x 28mm Curved
1276	26g x 28mm Curved
1277	23g x 28mm Curved
1278	23g x 28mm Straight

Knives and Blades

Stab Knives

for side port or scleral incisions

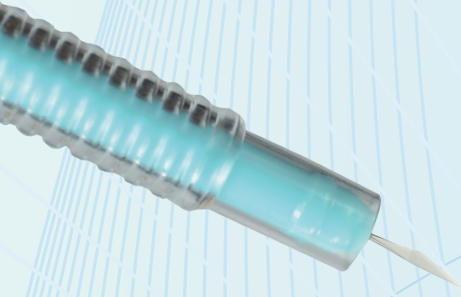

STAB KNIVES Full handle		
	standard	safety blade
15° Stab	I-15	I-15 P
22° Stab	I-22	I-22 P
30° Stab	I-30	I-30 P
45° Stab	I-45	I-45 P

Phaco Slit Knives, bevel

for clear corneal or scleral incisions



SLIT KNIVES Full handle, angled, bevel up		
	standard	safety blade
1,8 mm	F-18/A	F-18/AP1
2,0 mm	F-20/A	F-20/AP1
2,2 mm	F-22/A	F-22/AP1
2,4 mm	F-24/A	F-24/AP1
2,75 mm	F-27/A	F-27/AP1
3,00 mm	F-30/A	F-30/AP1
3,2 mm	F-32/A	F-32/AP1

Side Port Knives

to create a self-sealing incision during bi-manual Phaco procedures



SIDE PORT KNIFE Full handle, angled		
	standard	safety blade
1,2 mm	P-12/A	P-12/AP

Spoon Knives, protected blade

for scleral tunnel incision

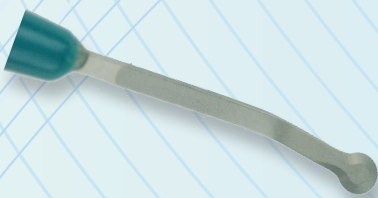

SPOON KNIFE Full handle, angled		
	standard	safety blade
Spoon circular	S-22/A	-----

Scleral Knife

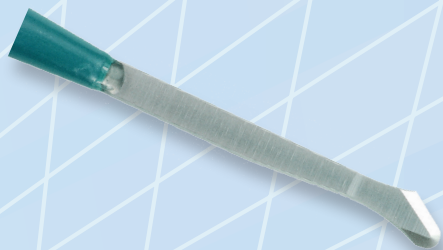

SCLERAL KNIFE Full handle, straight		
	standard	safety blade
SCLERAL	G-57/A	-----

MVR Knives

for vitreoretinal infusion port or paracentesis incision

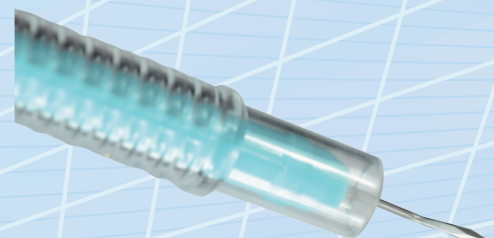

MVR KNIVES 20g Full handle		
	standard	safety blade
MVR 20g straight	V-20/R	V-20/RP
MVR 20g angled	V-20/A	V-20/AP

Blunt Tip Knives for IOL Insertion

for IOL enlargement

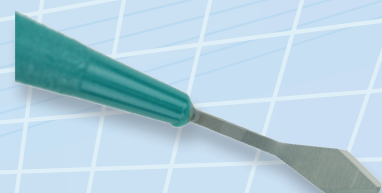

Blunt KNIVES for IOL Full handle		
	standard	safety blade
4,00 mm	L-40/A	L-40/AP
5,20 mm	L-52/A	L-52/AP

Crescent Knives

for scleral tunnel incision

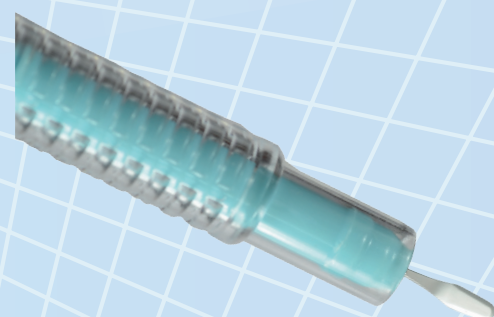

CRESCENT KNIVES Full handle		
	standard	safety blade
CRESCENT 2,00 mm straight	C-20/R	C-20/RP
CRESCENT 2,00mm angled	C-20/A	C-20/AP

Safety Blades



Closed Blade



Open blade

Standard Blades



Cataract and Retinal Custom Pack

VITREORETINAL CUSTOM PACK



INSTRUMENT	20g pack Composition: - Vitrectomy probe - Fiber optic light pipe - Infusion line - Cannula 4.0mm+3way stopcock	23g pack Composition: - Vitrectomy probe - Fiber optic light pipe - Set of 3 trocars +3 plugs - Infusion line+ 3way stopcock	25g pack Composition: - Vitrectomy probe - Fiber optic light pipe - Set of 3 trocars+ 3 plugs - Infusion line+ 3way stopcock
ALCON Accurus	CP-AAC20	CP-AAC23	CP-AAC25
ALCON Constellation	CP-ACT20	CP-ACT23	CP-ACT25
B&L Stellaris	CP-BST20	CP-BST23	CP-BST25
B&L Millenium	CP-BML20	CP-BML23	CP-BML25
DORC Associate 2500	CP-DAS20	CP-DAS23	CP-DAS25
DORC Associate High speed 6000	CP-DAH20	CP-DAH23	CP-DAH25
DORC Eva	CP-DEV20	CP-DEV23	CP-DEV25
GEUDER Megatron S4	CP-GMG20	CP-GMG23	CP-GMG25
OERTLI OS4	CP-OOS20	CP-OOS23	CP-OOS25
OPTIKON Revolution	CP-ORV20	CP-ORV23	CP-ORV25
OPTIKON Assistant	CP-OAS20	CP-OAS23	CP-OAS25
RUCK Qube	CP-RQU20	CP-RQU23	CP-RQU25
ZEISS Visalis	CP-ZVS20	CP-ZVS23	CP-ZVS25

CATARACT CUSTOM PACK



BASIC PACK

COMPOSITION

- Drape Table Cover 100x150 cm
- Opth. drape 100x120 w/hole + 1 Pocket with incis. Film
- Cannula Anterior Chamber 25 or 27G
- Cannula Hydrodissection 25 or 27G
- Slit knife 2,2 or 2, 4 or 2,75mm
- Incision Knife 15° or 1,1mm
- Insulin syringe 25 or 27G
- Syringe L/L 2,5-5-10 ml
- Gauze Swabs
- PVA Eye Spears (5 pcs)
- Pack base tray



Reusable instruments

Strumenti Chirurgici Personalizzati

Scegli differenti Manici e differenti Colori dei tuoi Set

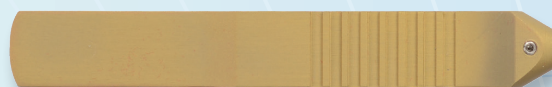

Manipolo Tipo A
Manipolo Piatto

Handle Type A
Flat Handle

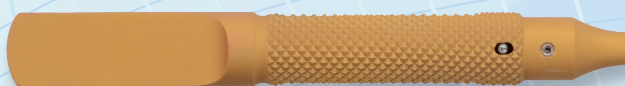

Manipolo Tipo B
Manipolo Tondo

Handle Type B
Round Handle



Manipolo Tipo C
Manipolo Tondo Lungo

Handle Type C
Long Round Handle



Manipolo Tipo D
Manipolo Tondo Corto

Handle Type D
Short Round Handle



Manipolo Tondo Tipo A
Ø6mm

Round Handle Type A
Ø6mm



Manipolo Tondo Tipo B
Ø8mm

Round Handle Type B
Ø8mm



Manipolo Tondo Tipo C
Ø8mm

Round Handle Type C
Ø8mm

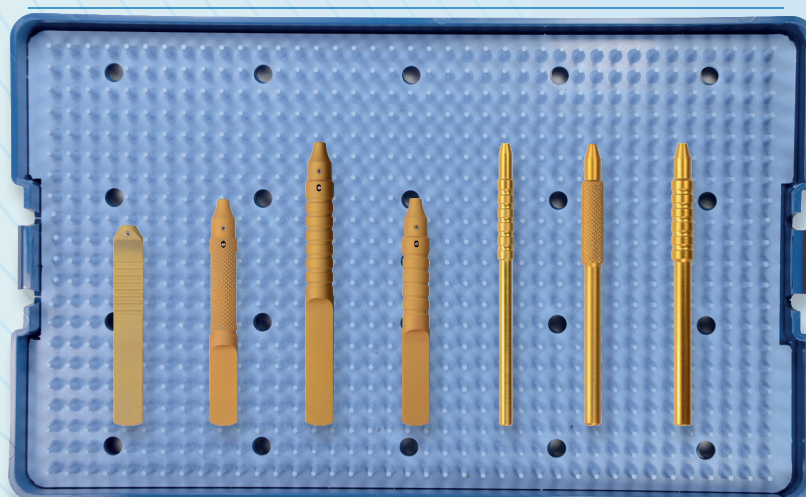

Customized Surgical Instruments

Choose Different Handles and Color Code your Surgical Set



Manipolo Tondo Tipo A
Ø6mm Blu

Round Handle Type A
Ø6mm Blue



Manipolo Tondo Tipo B
Ø8mm Oro

Round Handle Type B
Ø8mm Gold



Manipolo Tondo Tipo C
Ø8mm Verde

Round Handle Type C
Ø8mm Green



Manipolo Tondo Tipo A
Ø6mm Rosso

Round Handle Type A
Ø6mm Red



Manipolo Tondo Tipo B
Ø8mm Argento

Round Handle Type B
Ø8mm Silver



Manipolo Tondo Tipo C
Ø8mm Viola

Round Handle Type C
Ø8mm Violet

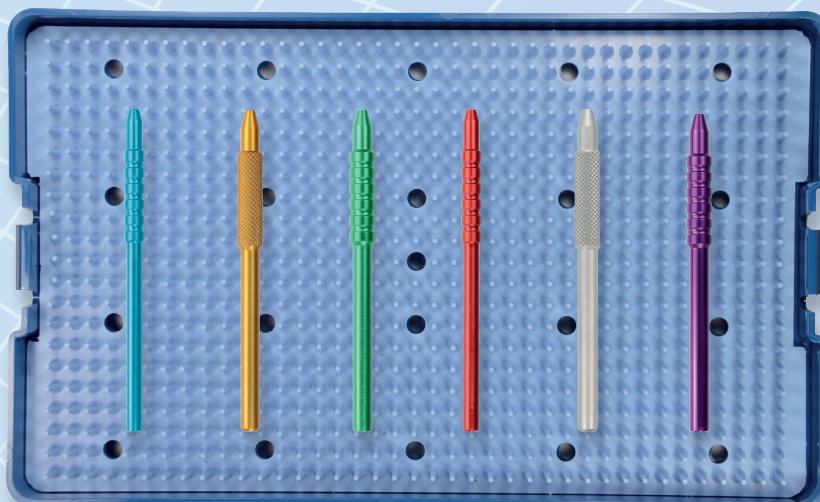

Pinze per Capsuloressi - *Capsulorhexis Forceps*

REGULAR

AK-1405

Pinza per capsuloressi
Capsulorhexis Forceps

**2.2 mm
incision**

Choose your favorite handle: type A, B, C or D
Choose your favorite color

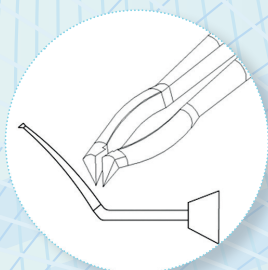

type A

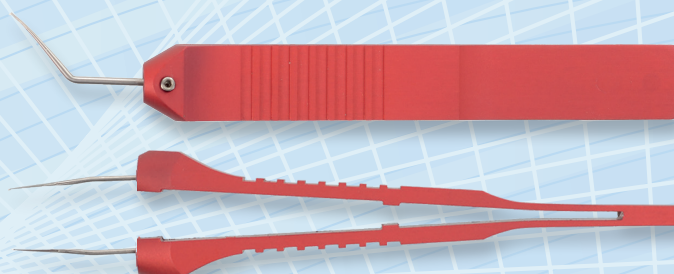

type B



type C

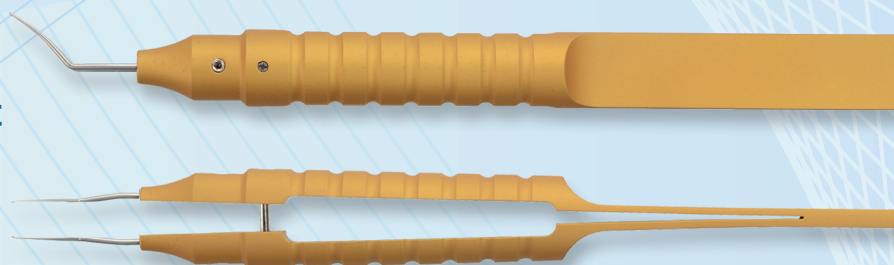

type D



-  Blue Handle
-  Red Handle
-  Silver Handle
-  Gold Handle
-  Green Handle
-  Violet Handle

Pinze per Capsuloressi

Capsulorhexis Forceps

CAPS

AK-1395

Pinza Coassiale per capsuloressi
Microincision Coaxial Capsulorhexis

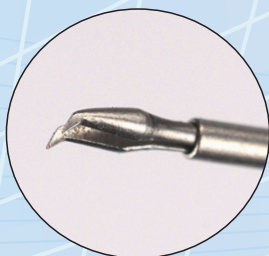

**0.7 mm
incision**

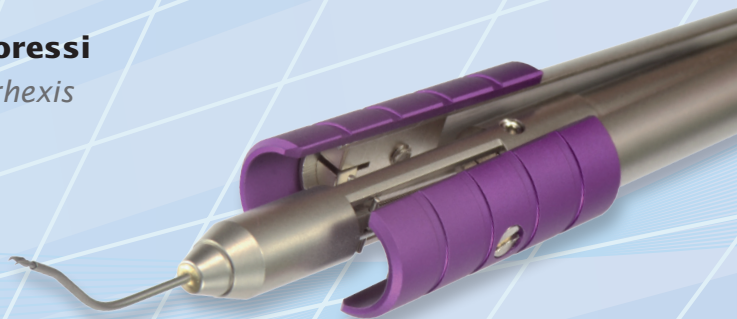

CROSS

AK-1390

Pinza Coassiale per capsuloressi ad azione incrociata
Microincision Cross-action Capsulorhexis

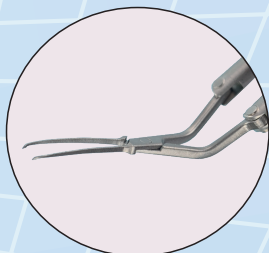

**1.8 mm
incision**



REGULAR

AK-1405C

Pinza per capsuloressi
Capsulorhexis Forceps

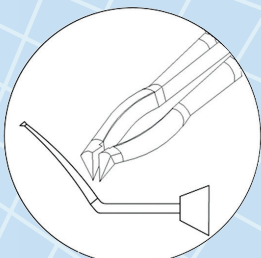

**2.2 mm
incision**

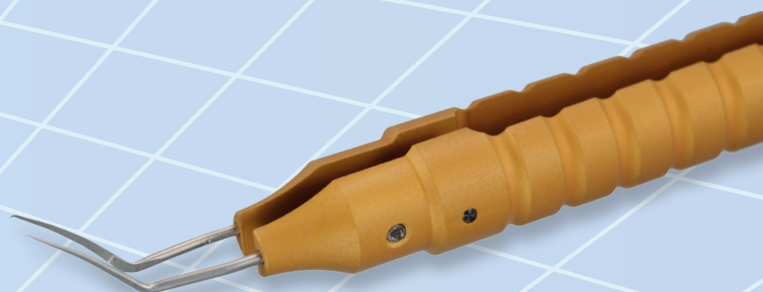

Available colors for all forceps:



Red



Gold



Green



Blue



Violet

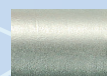

Silver

Choppers

Choose your favorite handle: type A, B or C
Choose your favorite color

-  Blue Handle
-  Red Handle
-  Silver Handle
-  Gold Handle
-  Green Handle
-  Violet Handle

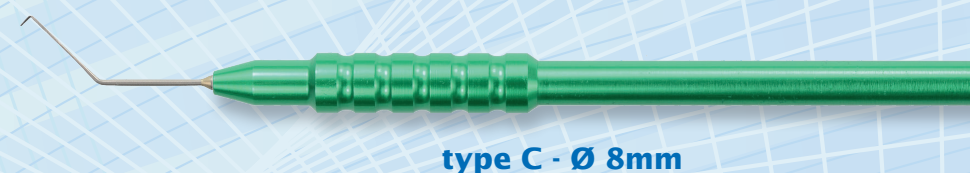

AK-1400

Chopper Carbonara
cutting 30° - sharp tip



AK-1398

Chopper Nagahara
60° blunt

AK-1399

Chopper Nagahara
90° blunt



AK-1396

Chopper Rosen
cutting 60°

AKti-flu

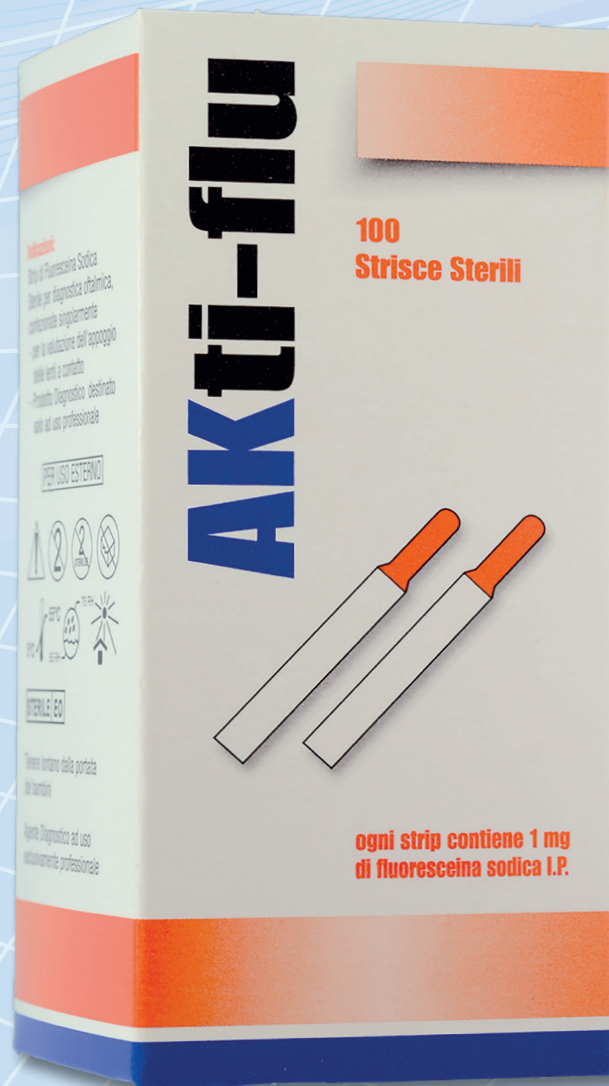

Floresceine, sterile, paked in single streap.
100 pcs per box, single blistered

Irrigazione / Aspirazione Coassiale

Coaxial Irrigation / Aspiration



AK-1292 Manipolo I/A, con punta intercambiabile (solo manipolo) *I/A Handpiece, interchangeable tip (only handle)*

I/A cannula with metal sleeve

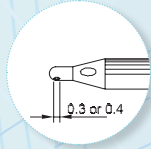

AK-1211 Cannula per I/A retta aspirazione 0,3 mm *I/A Cannula straight Asp. Port 0,3 mm*

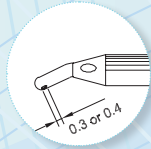

AK-1212 Cannula per I/A retta aspirazione 0,5 mm *I/A Cannula straight Asp. Port 0,5 mm*

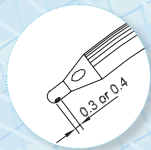

AK-1213 Cannula per I/A angolata 45° aspirazione 0,3 mm *I/A Cannula angled 45° Asp. Port 0,3 mm*

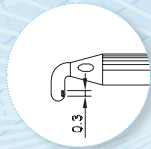

AK-1214 Cannula per I/A angolata 45° aspirazione 0,5 mm *I/A Cannula angled 45° Asp. Port 0,5 mm*

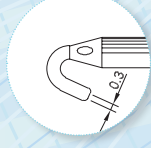

AK-1215 Cannula per I/A curva aspirazione 0,3 mm *I/A Cannula curved Asp. Port 0,3 mm*



AK-1216 Cannula per I/A curva aspirazione 0,5 mm *I/A Cannula curved Asp. Port 0,5 mm*

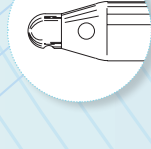

AK-1217 Cannula per I/A angolata 90° aspirazione 0,3 mm *I/A Cannula angled 90° Asp. Port 0,3 mm*

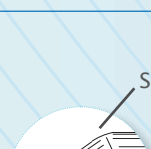

AK-1218 Cannula per I/A a J 0,3 mm *I/A Cannula J shaped Asp. Port 0,3 mm*

I/A cannula for silicone sleeve

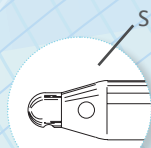

AK-1201 Cannula per I/A retta 20g aspirazione 0,3 mm *I/A Cannula straight 20g Asp. Port 0,3 mm*

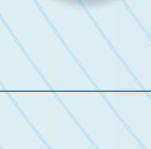

AK-1202 Cannula per I/A retta 20g aspirazione 0,5 mm *I/A Cannula straight 20g Asp. Port 0,5 mm*

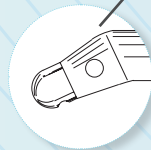

AK-1208 Cannula per I/A retta 21g aspirazione 0,3 mm *I/A Cannula straight 21g Asp. Port 0,3 mm*

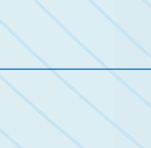

AK-1207 Cannula per I/A retta 22g aspirazione 0,3 mm *I/A Cannula straight 22g Asp. Port 0,3 mm*



AK-1203 Cannula per I/A angolata 45° 20g aspirazione 0,3 mm *I/A Cannula angled 45° 20g Asp. Port 0,3 mm*

AK-1204 Cannula per I/A angolata 45° 20g aspirazione 0,5 mm *I/A Cannula angled 45° 20g Asp. Port 0,5 mm*

AK-1206 Cannula per I/A angolata 45° 21g aspirazione 0,3 mm *I/A Cannula angled 45° 21g Asp. Port 0,3 mm*

AK-1205 Cannula per I/A angolata 45° 22g aspirazione 0,3 mm *I/A Cannula angled 45° 22g Asp. Port 0,3 mm*

AK-1200 O-ring di ricambio set di 5 coppie (5+5 pezzi) *Spare O-ring set 5 couples (5+5 pezzi)*

Irrigazione / Aspirazione bimanuale

Bi-manual Irrigation / Aspiration



AK-1391 Manipolo Aspirazione,
con punta intercambiabile
(solo manipolo)

*Aspiration Handpiece,
interchangeable tip
(only handle)*

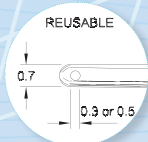

AK-1301

Punta per aspirazione
curva 22g, lucida,
foro da 0,3mm

*Aspiration Tip, curved
22g, polished,
Asp. Port 0,3mm*

AK-1302

Punta per aspirazione
curva 22g, lucida,
foro da 0,5mm

*Aspiration Tip, curved
22g, polished,
Asp. Port 0,5mm*

AK-1303

Punta per aspirazione
curva 22g, sabbata,
foro da 0,3mm

*Aspiration Tip, curved
22g, sanded,
Asp. Port 0,3mm*

AK-1304

Punta per aspirazione
curva 22g, sabbata,
foro da 0,5mm

*Aspiration Tip, curved
22g, sanded,
Asp. Port 0,5mm*

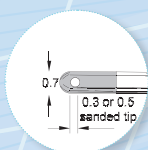

AK-1392 Manipolo Irrigazione,
con punta intercambiabile
(solo manipolo)

*Irrigation Handpiece,
interchangeable tip
(only handle)*

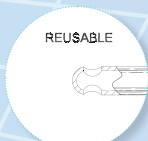

AK-1307

Punta per irrigazione
curva 22g, lucida, 2
fori da 0,45mm

*Irrigation Tip,
curved 22g, polished,
double port 0,45mm*

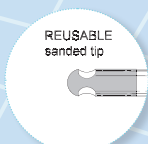

AK-1308

Punta per irrigazione
curva 22g, sabbata,
2 fori da 0,45mm

*Irrigation Tip,
curved 22g, sanded,
double port 0,45mm*



AK-1309

Punta per irrigazione
curva 22g, lucida,
terminale aperto

*Irrigation Tip,
curved 22g, polished,
open end*



Spasette portafferri - Surgical Trays

Mini Tray

1300A	Base, Lid, & Mat	3,8 x 6,9 x 1,9 cm
1310A	Base (deep), Lid & Mat	3,8 x 6,9 x 2,5 cm
1320A	Base (deep), Lid & Mat	3,8 x 6,9 x 3,2 cm

Large Instrument Tray

1500A	Base, Lid & Mat	25,4 x 38 x 1,9 cm
1520A	Base, Insert Tray, Lid & 2 Mats	25,4 x 38 x 3,8 cm
1522A	Base (deep), Lid & Mat	25,4 x 38 x 3,8 cm

Phaco Trays

2341A	Base, Lid & 2 Bars / 1 Slot	10,2 x 19 x 3,8 cm
2343A	Base, Lid & 2 Bars / 3 Slot	10,2 x 19 x 3,8 cm
2361A	Base, Lid & 2 Bars / 1 Slot	15,2 x 25,4 x 3,8 cm
2363A	Base, Lid & 2 Bars / 3 Slot	15,2 x 25,4 x 3,8 cm

Microsurgical instruments Tray

2600A	Base, Lid & Mat	6,4 x 15,2 x 1,9 cm
2610A	Base, Lid & Mat	6,4 x 15,2 x 3,2 cm
2700A	Base, Lid & Mat	6,4 x 19 x 1,9 cm
4600A	Base, Lid & Mat	10 x 16,5 x 1,9 cm
4700A	Base, Lid & Mat	10 x 19 x 1,9 cm
4710A	Base, Lid & Mat	10 x 19 x 3,8 cm
6100A	Base, Lid & Mat	15,2 x 25,4 x 1,9 cm
6120A	Base, Insert Tray, Lid & 2 Mats	15,2 x 25,4 x 3,8 cm
6124A	Base (deep), Lid & Mat	15,2 x 25,4 x 3,8 cm

Scope Trays

6510A	Base, Lid & Bars	6,6 x 40,6 x 3,8 cm
6511A	Base & Lid	6,6 x 40,6 x 3,8 cm
6512A	Base, Lid & Mat	6,6 x 40,6 x 3,8 cm
6550A	Base, Lid & Bars	16,5 x 45,7 x 3,8 cm
6551A	Base & Lid	16,5 x 45,7 x 3,8 cm
6552A	Base, Lid & Mat	16,5 x 45,7 x 3,8 cm
6560A	Base, Lid & Bars	16,5 x 45,7 x 7,6 cm
6561A	Base & Lid	16,5 x 45,7 x 7,6 cm
6562A	Base, Lid & Mat	16,5 x 45,7 x 7,6 cm

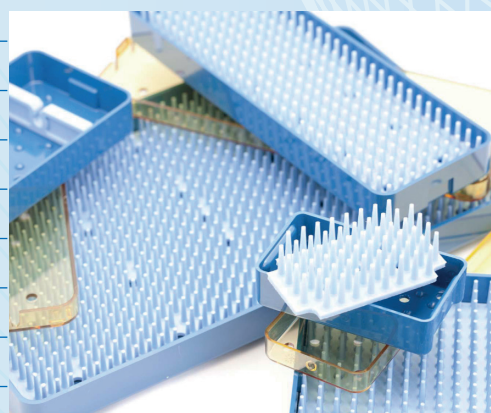

Manipoli per tip retiniche - *Retina tip Handpiece*

The Handpieces are reusable and have interchangeable disposable and reusable tips. Different tip colors help identify the instrument with ease.

This system allows the surgeon to change only the tips after a 23-25g surgery.



AK-1642GR (green) Manipolo per tip retiniche, doppia leva

Retina Handpiece, double lever

Squeeze Handle:

- High Constructive Technology
- Color Coded
- High Performance



AK-1642BL (blue) Manipolo per tip retiniche, doppia leva

Retina Handpiece, double lever



AK-1642RE (red) Manipolo per tip retiniche, doppia leva

Retina Handpiece, double lever

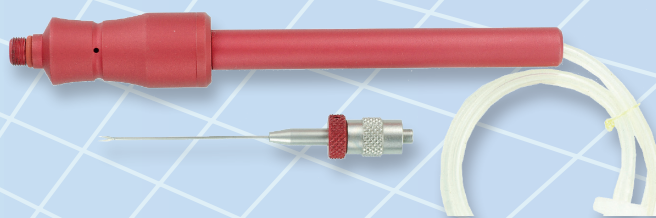

AK-1643 (red) Manipolo per taglio ripetitivo

Retina handpiece for continuous cut

Tip retiniche pluriuso - Reusable retinal Tips

20g

PUNTE PLURIUSO REUSABLE TIPS



AK-1650 Microforbice manuale 20g *Microscissors manual 20g*



AK-1651 Forbice per manipolo Ripetitivo (AK-1643) 20g *Microscissors for pneumatic Handpiece (AK-1643) 20g*

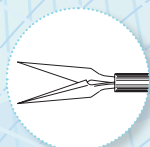

AK-1652 Microforbice retta lama a 45° 20g *Microscissor straight blade 45° 20g*



AK-1653 Microforbice curva 20g *Microscissor curved 20g*

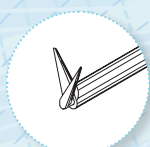

AK-1654 Microforbice 90° 20g *Microscissor 90° 20g*



AK-1655 Micropinza denti a coccodrillo 20g *Microforceps crocodile teeth 20g*

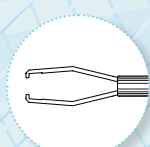

AK-1656 Micropinza presa in punta per ILM 20g *Microforceps ILM end-gripping 20g*



AK-1657 Micropinze angolate L = 1,7mm 20g *Angled microforceps L = 1,7mm 20g*



AK-1658 Micropinze sottoretiniche Presa laterale 20g *Microforceps, subretinal lateral gripping 20g*

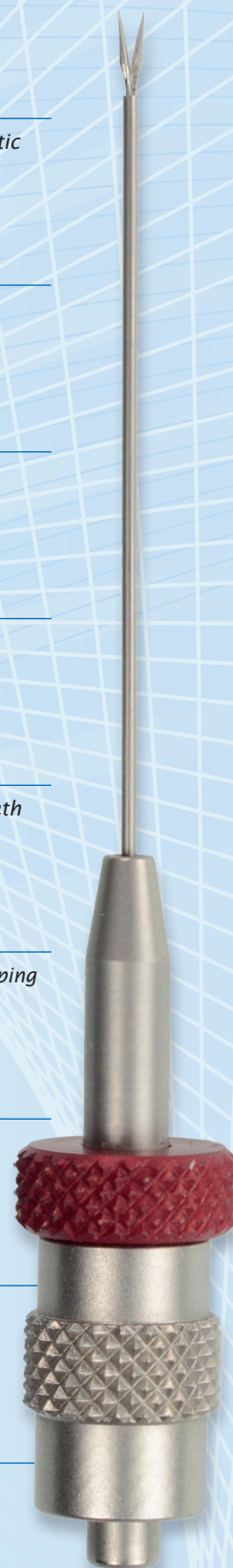

Prosegue sulla pagina seguente
Continued on the next page

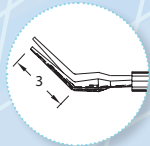

AK-1659

Micropinze sottoretiniche
L = 3mm
20g

Microforceps subretinal
L = 3mm
20g

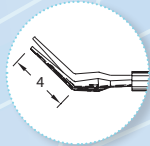

AK-1660

Micropinze sottoretiniche
L = 4mm
20g

Microforceps subretinal
L = 4mm
20g

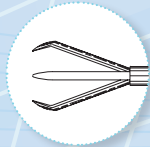

AK-1661

Micropinza per corpi estranei
20g

Foreign Bodies microforceps
20g



AK-1662

Micropinza tipo "Gotico"
20g

Microforceps "gothic"
20g

Tip retiniche - Retinal Tips

23g

PUNTE PLURIUSO

REUSABLE TIPS

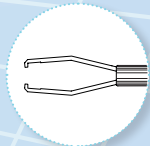

AK-1677

Micropinza presa in punta
per ILM
23g

Microforceps ILM end-gripping
23g

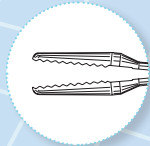

AK-1678

Micropinza denti coccodrillo
23g

Microforceps crocodile teeth
23g

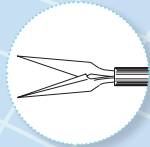

AK-1679

Microforbice retta
23g

Microscissor straight
23g



AK-1680

Microforbice curva
23g

Microscissor curved
23g



AKtive[®]

 **ITALY**
Ophthalmic Instruments

AKti-color[®]

 **ITALY**
Color Codec Instruments

Disclaimer:

Alcon®, Amo/Oms/ABBOTT®, Baush+Lomb®, Dorc®, Fritz Ruck®, Geuder®, Synergetics®, Optikon 2000®, Staar Surgical®, Oertli®, Universal®, Mediphacos® and any other company mentioned in this catalogue are registered names and trademarks. Aktive does not imply representation or affiliation with any of these companies in any manner.

All photos of products are not in scale

All Prices and models are subject to change without notice

Payment Terms:

International orders require prepayment including shipping charges.

All orders are shipped Fob ROME-ITALY

Satisfaction Guarantee Return goods policy

Unopened items returned for credit must be accompanied by a "return of goods authorization number" (RGA) and the reason of the return.

Return Policy and Restocking Changes:

- Saleable product can be returned within 30 days of purchase for a full refund less a 15% restocking charge
- Saleable product can be returned from 30 days to 1 year of purchase for a full refund less a 60% restocking charge

Note:

- Saleable products returned in factory after 1 year of purchase are not susceptible to refund
- Defective products at time of receipt by customer receive full credit
- Products shipped in error receive full credit

Customer must prepay all freight charges on stock returns except for defective products or wrong shipment.

Goods that will not be accepted:

- **"Special order" or "custom product"**
- **Products not in original Aktive Package**
- **Discontinued products**

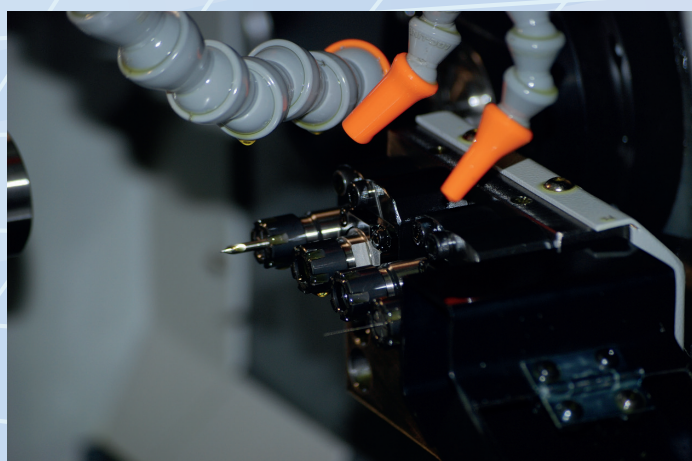
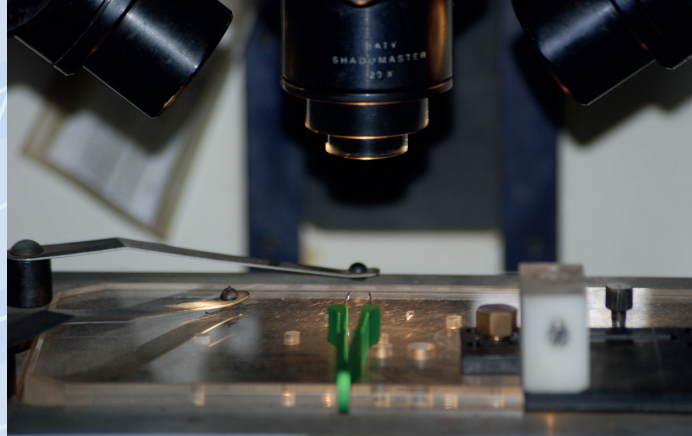

AKTive®
ITALY
Ophthalmic Instruments



Distributed by



Via Giacomo Delitala, 106 - 00173 Rome, Italy
info@aktive-corp.com - www.aktive-corp.com
Tel. (+39) 0688640509 - Fax (+39) 0688384287